

# Regioselective Protection and Deprotection of Inositol Hydroxyl Groups

Kana M. Sureshan, Mysore S. Shashidhar,\* Thoniyot Praveen, and Tanya Das

Division of Organic Synthesis, National Chemical Laboratory, Pune 411 008, India

Received May 19, 2003

## Contents

1. Introduction	4477	3. Selective Protection/Deprotection of Inositols	4495
2. Regioselective Protection of Hydroxyl Groups of <i>myo</i> -Inositol and Its Derivatives	4479	Other than the <i>myo</i> -Isomer	
2.1. Regioselective Protection of <i>myo</i> -Inositol: Selectivity among the Six Hydroxyl Groups	4479	3.1. <i>chiro</i> -Inositols ( <b>D2</b> , <b>L2</b> )	4495
2.2. Regioselective Protection of <i>myo</i> -Inositol-Based Pentols: Selectivity among Five Hydroxyl Groups	4482	3.2. <i>scyllo</i> -Inositol ( <b>3</b> )	4498
2.2.1. <i>myo</i> -Inositol-Based 1(3),2,4,5,6-Pentols	4482	3.3. <i>epi</i> -Inositol ( <b>4</b> )	4498
2.2.2. <i>myo</i> -Inositol-Based 1,3,4,5,6-Pentols	4483	3.4. <i>cis</i> -Inositol ( <b>5</b> )	4499
2.3. Regioselective Protection of <i>myo</i> -Inositol-Based Tetrols: Selectivity among Four Hydroxyl Groups	4483	3.5. <i>muco</i> -Inositol ( <b>6</b> )	4499
2.3.1. <i>myo</i> -Inositol-Based 1,2,3,5-Tetrols	4483	4. Conclusions	4499
2.3.2. <i>myo</i> -Inositol-Based 1(3),2,4(6),5-Tetrols	4483	5. Acknowledgment	4500
2.3.3. <i>myo</i> -Inositol-Based 1(3),2,5,6(4)-Tetrols	4483	6. References	4500
2.3.4. <i>myo</i> -Inositol-Based 1,3,4,5-Tetrols	4483		
2.3.5. <i>myo</i> -Inositol-Based 1,3,4,6-Tetrols	4484		
2.3.6. <i>myo</i> -Inositol-Based 1(3),4,5,6-Tetrols	4484		
2.4. Regioselective Protection of <i>myo</i> -Inositol-Based Triols: Selectivity among Three Hydroxyl Groups	4485		
2.4.1. <i>myo</i> -Inositol-Based 1(3),2,5-Triols	4485		
2.4.2. <i>myo</i> -Inositol-Based 1(3),2,6(4)-Triols	4485		
2.4.3. <i>myo</i> -Inositol-Based 1,3,5-Triols	4486		
2.4.4. <i>myo</i> -Inositol-Based 1,3,(4)6-Triols	4486		
2.4.5. <i>myo</i> -Inositol-Based 2,4,6-Triols	4486		
2.4.6. <i>myo</i> -Inositol-Based 4,5,6-Triols	4488		
2.5. Regioselective Protection of <i>myo</i> -Inositol-Based Diols: Selectivity among Two Hydroxyl Groups	4488		
2.5.1. <i>myo</i> -Inositol-Based 1(3),2-Diols	4488		
2.5.2. <i>myo</i> -Inositol-Based 1(3),4(6)-Diols	4489		
2.5.3. <i>myo</i> -Inositol-Based 1(3),5-Diols	4489		
2.5.4. <i>myo</i> -Inositol-Based 1(3),6(4)-Diols	4490		
2.5.5. <i>myo</i> -Inositol-Based 2,4(6)-Diols	4491		
2.5.6. <i>myo</i> -Inositol-Based 2,5-Diols	4491		
2.5.7. <i>myo</i> -Inositol-Based 4(6),5-Diols	4491		
2.5.8. <i>myo</i> -Inositol-Based 4,6-Diols	4491		
2.6. Regioselective Regeneration of Hydroxyl Groups from Protected <i>myo</i> -Inositols	4492		
2.6.1. Selective Cleavage of Ketals	4492		
2.6.2. Selective Cleavage of Ortho Esters	4492		
2.6.3. Selective Cleavage of Esters	4493		
2.6.4. Selective Cleavage of Ethers	4495		

## 1. Introduction

The past decade witnessed a renaissance in the chemistry and biochemistry of inositols, mainly due to the realization of the role played by phosphorylated *myo*-inositol (**1**, Chart 1) derivatives in important biological phenomena<sup>1</sup> such as cellular signal transduction, calcium mobilization, insulin stimulation, exocytosis, cytoskeletal regulation, intracellular trafficking of vesicles, and anchoring of certain proteins to cell membranes. A growing number of membrane proteins are being identified as harbored to cell membranes by glycosylphosphatidylinositol (GPI) anchors. Although our understanding of the phosphoinositide-based cellular process is continually widening, a clear understanding of the biological role played by a bewildering array of *myo*-inositol phosphates and their lipid derivatives identified and/or isolated from plant as well as animal cells is still lacking, making it clear that the area is far more complex than originally imagined. Progress in understanding this well-developed area is greatly aided by the availability of synthetic phosphoinositols, their derivatives, and analogues. Discovery of compounds which could specifically interfere with steps of the *myo*-inositol cycle would be of great use as biochemical tools as well as potential drug leads. Consequently, the chemical emphasis in this field is now focusing on the synthesis of structurally modified inositol derivatives as potential enzyme inhibitors and receptor antagonists for pharmacological intervention in various diseases.

Inositols are cyclohexanehexols<sup>2</sup> (Chart 1): four isomers, viz., *myo*-, *neo*-, *chiro*-, and *scyllo*-inositol, have been recognized to occur in nature, while the others, viz., *cis*-, *epi*-, *allo*-, and *muco*-inositol are unnatural synthetic isomers. *myo*-Inositol (**1**) occurs widely in nature in both free and combined forms. Although **1** has the meso configuration, in the com-

\* Corresponding author. E-mail: shashi@dalton.ncl.res.in. Fax: +91-20-589-3153.

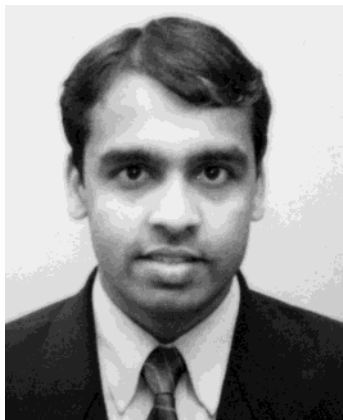

K. M. Sureshan was born (1973) in Eramam, India. He received his Ph.D. (2002) from the University of Pune, India, under the supervision of Dr. M. S. Shashidhar. He received the National Merit Scholarship while pursuing bachelor's and master's degrees, and a Junior Research Fellowship and a Senior Research Fellowship from CSIR, Government of India, during his Ph.D. work. Presently he is working as a JSPS postdoctoral fellow with Prof. Yutaka Watanabe, Ehime University, Japan. His research interest includes natural product synthesis, development of new methodologies, and supramolecular chemistry.



Mysore S. Shashidhar is a middle order management level scientist and a project leader at the National Chemical Laboratory. He initially attended school and college, mostly due to social pressure, at Bangalore. He then cultivated an interest in chemistry and obtained his master's degree in chemistry from the Indian Institute of Technology, Madras, and his doctoral degree (under the guidance of Professor M. V. Bhatt) in organic chemistry from the Indian Institute of Science, Bangalore. His desire to see other countries and cultures took him to the University of Oregon, where he did his postdoctoral research (related to phosphatidylinositol-specific phospholipase C) in the laboratories of Professors O. Hayes Griffith and John F. W. Keana. He then realized that he had stayed away far too long from his own culture and returned to his mother land, where he joined the National Chemical Laboratory at Pune. His current research interests include exploration of the chemistry and structure of cyclitols, their derivatives, and neighboring group effects.

bined form it occurs almost always as an optically active derivative. Despite a reasonably good understanding of the biological roles played by *myo*-inositol and its phosphorylated derivatives, there is still no definite understanding of the biological functions of other naturally occurring isomeric cyclitol derivatives.

The key intermediates for the synthesis of biologically important derivatives of inositols are the corresponding hydroxyl group-protected derivatives (having free hydroxyl group(s) at desired positions). Protected inositol derivatives and their analogues have been prepared (Scheme 1) from (a) naturally



Thoniyot Praveen is a native of Kerala, India. He obtained his Ph.D. in organic chemistry (with Dr. M. S. Shashidhar) for his work on the chemistry of inositols at the National Chemical Laboratory, Pune, India, in 2000. He then moved on to the laboratory of Dr. Bruno Bujoli, Laboratoire Synthèse Organique, Université de Nantes, France, where he worked in the areas of asymmetric catalysis and organic-inorganic hybrid materials. Currently he is a postdoctoral researcher in Professor Rebecca Braslau's group at the University of California, Santa Cruz, pursuing the synthesis of biomimetic membranes with the aid of nitroxide-mediated living free radical polymerization.



Tanya Das is a native of Kolkata, India. She obtained her M.Sc. in chemistry from Jadavpur University, Kolkata, India. She then obtained a research fellowship from the University Grants Commission, New Delhi, and worked with Dr. M. S. Shashidhar at the National Chemical Laboratory, Pune. This work eventually led to her Ph.D. degree from the Pune University, India. She is currently a Senior Lecturer in Organic Chemistry at Dinabandhu Andrews College, Kolkata, India.

occurring cyclitols and their derivatives [*myo*-inositol (**1**),<sup>1b,3</sup> pinitol (**D9**),<sup>4</sup> and quebrachitol (**L10**)];<sup>4</sup> (b) carbohydrates [glucose (**11**),<sup>5</sup> D-xylose (**12**),<sup>5h,6</sup> D-galactose (**13**),<sup>5f</sup> D-mannitol (**14**),<sup>7</sup> and L-iditol (**15**)];<sup>8</sup> (c) chiral acids (tartaric acid, quinic acid, and dehydroshikimic acid);<sup>9</sup> (d) benzene and its derivatives (**17**);<sup>10</sup> (e) cyclohexene (**18**);<sup>11</sup> and (f) *p*-benzoquinone (**19**).<sup>12</sup>

Syntheses starting from **1** necessarily involve several protection and deprotection steps (of the six secondary hydroxyl groups) and chemical or enzymatic resolution of intermediates to obtain the required enantiomerically pure protected inositol. Syntheses starting from chiral **D9** and **L10** avoid the problem of resolution but require the inversion of one of the axial hydroxyl groups to obtain derivatives of **1**. The synthetic routes from carbohydrates **11–15** give access to optically pure intermediates, since the starting materials are chiral, but involve C–C bond

Chart 1

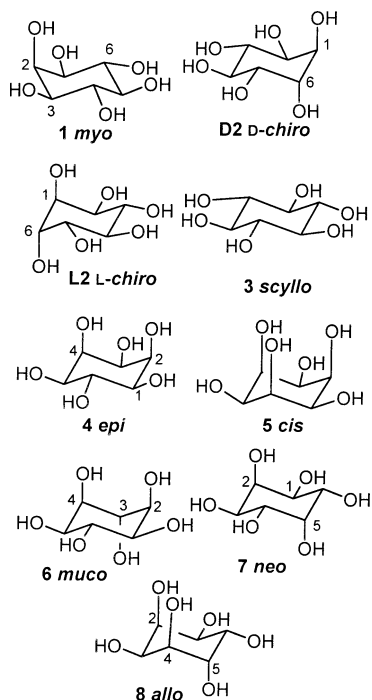
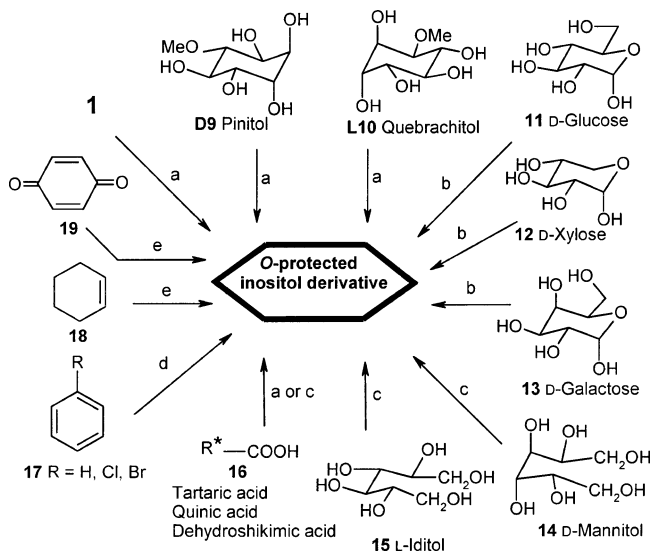
Scheme 1<sup>a</sup>

<sup>a</sup> (a) Hydroxyl groups protection/deprotection; (b) Ferrier reaction; (c) SmI<sub>2</sub>-mediated cyclization; (d) *Pseudomonas putida*-mediated hydroxylation followed by dihydroxylation reactions; (e) hydroxylation.

formation, usually via Ferrier cyclization<sup>13</sup> reaction. The syntheses from benzene or its derivatives (17) involve their microbial oxidation to cyclohexadienediol and have an advantage in that they can be used to generate isomeric inositols or their derivatives from a common intermediate. Among the different strategies developed for the synthesis of protected *myo*-inositol derivatives and their analogues, those starting from commercially available **1** are preferred many times because of its low cost and convenience. Several methods are now available for the desymmetrization of symmetric *myo*-inositol derivatives and efficient resolution of racemic *myo*-inositol derivatives, which provide enantiomerically pure products.<sup>14</sup>

Tremendous efforts have been made in synthesizing partially protected inositols having free hydroxyl groups at specific positions. The selectivity patterns observed could be dependent on various factors such as inherent acidity of the free hydroxyl groups, their hydrogen bonding or other interactions with neighboring functional groups, nature of the protecting groups already present, conformation of the carbocyclic ring, reaction conditions, and reagents used. In some cases, the reasons for the observed selectivity patterns are obvious, while in other cases they are debatable (see the following sections). An attempt has been made in the following sections to survey and categorize selective protection and deprotection reactions, so that practicing chemists/biologists may be able to choose a method for the preparation of protected inositol derivatives, depending on their requirement. In addition to being useful for those who work with inositols, it is hoped that this review would help to widen the scope of using cyclitol derivatives for the synthesis of various classes of natural and unnatural compounds with interesting properties (see section 4). Emphasis is given to the literature published between 1985 and the end of the year 2002, involving selective protection/deprotection of inositol hydroxyl groups. Although some of the earlier relevant work is included, earlier reviews and monographs must be referred to for details.<sup>1b,15</sup>

## 2. Regioselective Protection of Hydroxyl Groups of *myo*-Inositol and Its Derivatives

*myo*-Inositol is a *meso*-isomer of 1,2,3,4,5,6-hexahydroxycyclohexane with five equatorial hydroxyl groups and an axial hydroxyl group. The carbon bearing the axial hydroxyl group is designated as C2, and the other ring carbons can be numbered from C1 to C6, starting from a C1 atom and proceeding around the ring in clockwise or anticlockwise fashion. There is a plane of symmetry passing through C2 and C5 atoms. According to convention, an anticlockwise numbering in an asymmetrically substituted *myo*-inositol leads to the configurational D- prefix (Chart 2), and the clockwise numbering gives the substituted *myo*-inositol an L- prefix.<sup>1d,16</sup> An IUPAC nomenclature allowing all biologically relevant compounds to be denoted as D-isomers has also been proposed.<sup>17</sup> Although most of the asymmetrically substituted *myo*-inositol derivatives included in this article are racemic, for clarity and simplicity they are represented by only one enantiomer in charts and schemes. For all the enantiomers mentioned, the corresponding compound numbers are prefixed by a D or L.

Chart 2

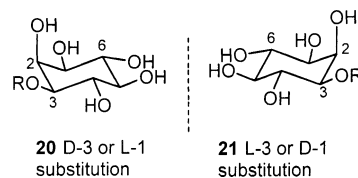

### 2.1. Regioselective Protection of *myo*-Inositol: Selectivity among the Six Hydroxyl Groups

Traditionally, the hydroxyl groups of **1** were initially protected as ketals of acetone,<sup>18</sup> cyclohex-

anone,<sup>19</sup> or cyclopentanone;<sup>19a,20</sup> however, the cyclopentylidene ketals have not been used extensively for synthetic purposes. An attempt<sup>21</sup> to synthesize benzylidene derivatives of *myo*-inositol led to a mixture of products consisting of *myo*- and *epi*-inositol derivatives, but the yields seemed to be irreproducible. Direct allylation of *myo*-inositol using dibutyltin oxide and allyl bromide led to the formation of a mixture of products, 1,3,4-triallyl ether being the major product.<sup>22</sup> Although this procedure does not seem to be suitable for multistep syntheses, these experiments suggested that the order of reactivity of hydroxyl groups in **1** is C1 ~ C3 > C4 > C5. Previous workers studying regioselectivity in carbohydrates have suggested that hydrogen bonding of the proton on the reacting hydroxyl group to a cis-vicinal oxygen can enhance its reactivity relative to other hydroxyl groups without such possibilities.<sup>23</sup>

Angyal and MacDonald<sup>18a</sup> synthesized isopropylidene derivatives of different inositols and quercitols. *myo*-Inositol, on treatment with acetone in the presence of a Lewis acid (ZnCl<sub>2</sub>) and acetic acid, followed by acetylation, gave the tetraacetate **22**, which was converted to **23** (Scheme 2) by alcoholysis. Later, Gigg

#### Scheme 2<sup>a</sup>

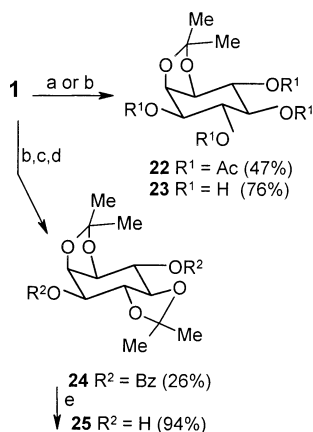

<sup>a</sup> (a) Dry acetone, ZnCl<sub>2</sub>, AcOH, reflux, 9 h; Ac<sub>2</sub>O, pyridine; (b) 2,2-dimethoxypropane, TsOH, DMSO, 110 °C; (c) Et<sub>3</sub>N; (d) pyridine, BzCl, 2 h; (e) NaOH, MeOH, reflux.

et al.<sup>18b,c</sup> obtained **23** using 2,2-dimethoxypropane instead of acetone, in good yield. Desai and co-workers<sup>24</sup> prepared **23** and found conditions to isolate it by crystallization in about 75% yield. Ketalization of **1** with an excess of 2,2-dimethoxypropane<sup>18c</sup> gave a mixture of ketals from which the diketal **25** was isolated as its dibenzoate **24**, owing to its lower solubility in DMF.

Angyal et al.,<sup>19b</sup> and later Baker et al.,<sup>19e</sup> synthesized the cyclohexylidene derivative **26** (Scheme 3) by the treatment of **1** with cyclohexanone in the presence of an acid catalyst. The monoketal **26** was formed by the in situ hydrolysis of the *trans*-cyclohexylidene group in the initially formed mixture of bis-cyclohexylidene derivatives. A convenient method for the isolation of **26** by precipitation, after the reaction of **1** with 1,1-dimethoxycyclohexane, has also been described.<sup>9e</sup> Angyal et al.,<sup>19a</sup> and later Garegg et al.,<sup>19c</sup> isolated dicyclohexylidene derivatives **27**–**29** obtained by the reaction of **1** with 1-ethoxycyclohexene.

#### Scheme 3<sup>a</sup>

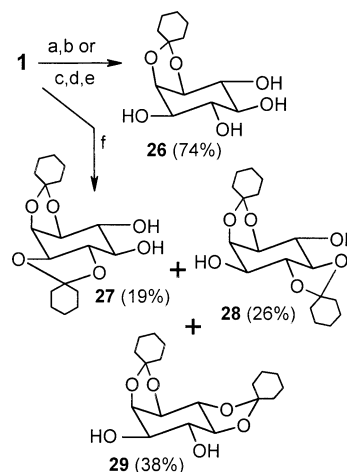

<sup>a</sup> (a) Cyclohexanone, TsOH, benzene; (b) benzene–light petroleum–ethanol (4:5:1); (c) 1,1-dimethoxycyclohexane, TsOH, DMSO; (d) CHCl<sub>3</sub>, NEt<sub>3</sub>; (e) filtration; (f) 1-ethoxycyclohexene, TsOH, DMF or DMSO.

Bruzik et al.<sup>25</sup> synthesized diastereomeric camphor ketals (**D30**–**D33**, Scheme 4) and separated them as

#### Scheme 4<sup>a</sup>

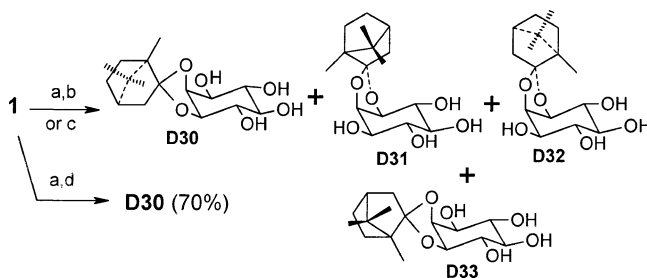

<sup>a</sup> (a) D-Camphor (2 equiv), DMSO, concentrated H<sub>2</sub>SO<sub>4</sub>, 68–70 °C; (b) CHCl<sub>3</sub>–MeOH–H<sub>2</sub>O (90:10:2), TsOH, room temperature, 1.5 h; (c) camphor dimethyl ketal, TMS triflate, DMSO, 110 °C, 97%; (d) CHCl<sub>3</sub>–MeOH–H<sub>2</sub>O (50:5:1), TsOH, room temperature, 12–16 h.

their tetrabenzyl ethers. *myo*-Inositol was first treated with 2 equiv of D-camphor in the presence of sulfuric acid, and the mixture of products thus obtained was hydrolyzed selectively to obtain a diastereomeric mixture of monoketals, which were benzylated and separated as their tetrabenzyl ethers. Later the same group modified<sup>25b,d</sup> the procedure by using D-camphor dimethyl acetal (instead of camphor) in the presence of TMS triflate and separated the four tetrols **D30**–**D33** in better yield (97%). Salamończyk and Pietrusiewicz<sup>26</sup> prepared the diastereomer **D30** by the acid hydrolysis of a mixture of ketals obtained by the reaction of **1** with D-camphor. This procedure led to the formation of a single product, **D30** (65–70%), due to a precipitation-driven equilibrium. It is surprising to see that different product formations are reported<sup>25a,26</sup> after the partial hydrolysis of a mixture of camphor ketals under almost identical conditions.

A comparison of the experimental procedures available in the literature shows that the use of DMF (instead of DMSO) as a solvent and transketalization with dimethyl ketals (rather than the use of the required ketone) for the ketalization of **1** gives cleaner

products in better yields. As is evident from literature reports, the isolated yield of a single regioisomer of diketal of **1** does not exceed 40%, and often the isomeric ketals are not easy to separate by chromatography. This could be due to the formation of oligomeric ketal derivatives, in addition to the formation of regioisomers.

Ley et al.<sup>27</sup> reported a highly regioselective formation of the bis-dispoke acetal **36** on treatment of **1** with bis-dihydropyran **35** (Scheme 5). Similarly,

**Scheme 5<sup>a</sup>**

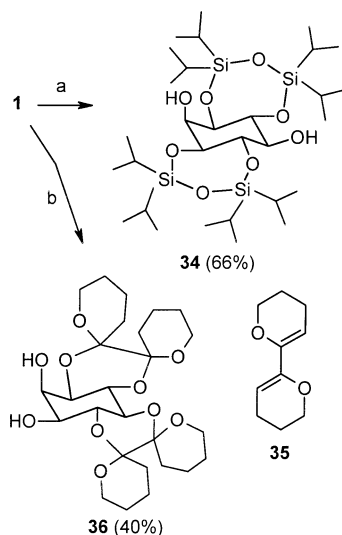

<sup>a</sup> (a) TIPDSCl<sub>2</sub> (2.5 equiv), pyridine, room temperature; (b) **35**, CSA, DMF, 100 °C.

highly regioselective introduction of a tetraisopropyl-disiloxane-1,3-diyl (TIPDS) group or a bis(butane-2,3-diacetal) group to **1** has been achieved.<sup>28</sup> TIPDS-protected *myo*-inositol derivatives (such as **34**) were used to synthesize *myo*-inositol phosphates (section 2.5.6).<sup>28a</sup> It is important to note that bis-dihydropyran, disiloxane, and butanedione reagents do not form 1,2 (or 2,3)-cis derivatives, unlike in ketal formation reactions, wherein cis-ketals are the preferred products. Consequently, these three reagents provide protected *myo*-inositol derivatives in which the C2-OH is free (see section 2.2.1). Thus, the use of TIPDSCl<sub>2</sub> represents an alternative strategy to the standard inositol ketal protection, which affords derivatives with free axial hydroxyl groups. Initial investigations<sup>29</sup> on the use of TIPDSCl<sub>2</sub> for the protection of diols revealed that the reagent initially adds to the most accessible hydroxyl group of a molecule and then proceeds to cyclize to form a seven- or eight-membered ring. It has also been well established<sup>22</sup> (also see following sections) for both *myo*- and *chiro*-inositol that the equatorial hydroxyl groups vicinal to the axial hydroxyl group are the most reactive toward both alkylation and acylation. Also, an examination of the models suggests that steric strain or constraints imposed by the axial C2-OH for the formation of dioxane or disiloxane derivatives could contribute to the nonformation of cis derivatives. Although reactions of inositols with trans-diol protecting reagents are selective, they often result in modest to low yields of the protected inositol derivative and, being bulky protecting groups, might

offer high steric hindrance for further derivatization of the remaining hydroxyl groups.<sup>30</sup>

Lee and Kishi<sup>31</sup> reported the simultaneous protection of three (C1, C3, and C5) hydroxyl groups of **1** as orthoformate (Scheme 6). They used the ortho-

**Scheme 6<sup>a</sup>**

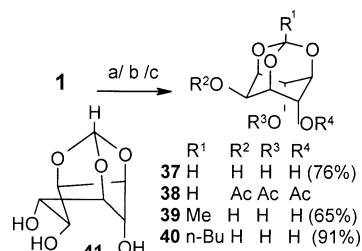

<sup>a</sup> (a) (EtO)<sub>3</sub>CH, DMF, TsOH, 100 °C; (b) (EtO)<sub>3</sub>CCH<sub>3</sub>, DMF, TsOH, 100 °C; (c) (EtO)<sub>3</sub>CC<sub>4</sub>H<sub>9</sub>, DMSO, CSA, 60 °C.

formate **37** as the starting material for the synthesis of enterobactin analogues.<sup>32</sup> Earlier, in 1966, Luk'yakov and Tolkachev<sup>33</sup> disclosed the synthesis of a mono-orthoformate of *myo*-inositol; however, their assignment of its structure as **41** was incorrect. Unfortunately, no physical data were available from the first report<sup>33</sup> which could be compared to conclude that this product was identical with the orthoformate **37** obtained by Lee and Kishi.<sup>31</sup> Protection of the C1-, C3-, and C5-hydroxyl groups of **1** as ortho esters **39** and **40** is also reported.<sup>34</sup> As in the case of the preparation of ketals, use of DMF instead of DMSO as a solvent for the reaction results in cleaner products (*myo*-inositol ortho esters) with reproducible yields.<sup>35</sup> Formation of 1,2-*O*-ethylidene-*myo*-inositol during the reaction of **1** with triethyl orthoformate in DMSO has also been reported.<sup>35e</sup> Andersch and Schneider<sup>35c</sup> prepared the triacetate **38** on a 100-g scale, which on methanolysis gave the triol **37** in good yield, and we reported a rapid method for the preparation of **37** and **39** via their tribenzoates.<sup>35f</sup> Protection of three hydroxyl groups of a fluorinositol derivative as the corresponding orthoformate is also reported, although in much lesser yield.<sup>36</sup> The potential of ortho esters of **1** as intermediates for the preparation of several natural and unnatural cyclitol derivatives is evident from recent publications (see section 2.4.5).

Watanabe et al.<sup>37</sup> described a short and practical synthesis of racemic *myo*-inositol 1,3,4,5-tetrakisphosphate via the direct benzoylation of **1**. They benzoylated **1** with 3.5 equiv of benzoyl chloride in pyridine at different temperatures and obtained tetrabenzoates **42**, **43**, and the pentabenzoate **44** (Scheme 7). The pentabenzoate **44** was the major product of benzoylation at room temperature, while the tetrabenzoate **42** was the major product at 65 and 90 °C. These results were explained on the basis of the solubility of partially benzoylated inositols (**1** is sparingly soluble in pyridine at room temperature, and the benzoylated derivatives with fewer benzoyl groups tend to be less soluble as compared to those with more benzoyl groups). However, the possibility of benzoyl migration being responsible for the observed predominant formation of isomeric benzoates was not ruled out. Acylation of **1** with *p*-anisoyl

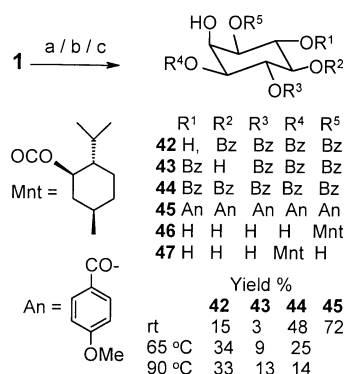
Scheme 7<sup>a</sup>

<sup>a</sup> (a) BzCl (3.5 equiv), pyridine, 2 h; (b) AnCl, pyridine, 0 °C to room temperature; (c) (i) perborylation, (ii) Bu<sub>2</sub>Sn(acac)<sub>2</sub>, MntCl.

chloride resulted in the formation of the pentaester **45**, which was isolated as a crystalline solid.<sup>38</sup> Under the reaction conditions, acylation of the axial C2-OH occurred only to a negligible extent. Regioselective 1-*O*-acylation of *myo*-inositol and simultaneous optical resolution has been achieved by perborylation, transmetalation using di-*n*-butyltin-bis-acetylacetonate, followed by acylation with (–)-menthyl chloroformate.<sup>39</sup> The diastereomerically pure **47** obtained was used for the synthesis of D-*myo*-inositol 1,4,5-trisphosphate [Ins(1,4,5)P<sub>3</sub>].

## 2.2. Regioselective Protection of *myo*-Inositol-Based Pentols: Selectivity among Five Hydroxyl Groups

### 2.2.1. *myo*-Inositol-Based 1(3),2,4,5,6-Pentols

During the synthesis of metabolically stable analogues of Ins(1,4,5)P<sub>3</sub>, Fauq and co-workers<sup>40</sup> reported diisopropylideneation of **D48**. Reaction<sup>41</sup> of **D48** with 2-methoxypropene at 65 °C gave **D51** and **D54** in the ratio 2:1 (Scheme 8). The same reaction, when carried out at 80 °C, gave **D51** and **D54** in the ratio 1:2.3. This reversal of ratio of products at higher temperature could be due to the isomerization of **D51** to **D54** in the presence of the acid catalyst. Angyal and Hoskinson<sup>42</sup> prepared isopropylidene derivatives of both racemic **49** and (–)-bornesitol by the ketal exchange method. Racemic **49**, on treatment with 2,2-

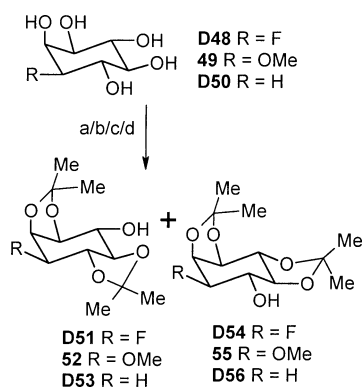
Scheme 8<sup>a</sup>

<sup>a</sup> (a) 2-Methoxypropene, CSA, DMF, 80 °C, 4 h, 83% (**D51**:**54** = 1:2.3); (b) as in (a) at 65 °C, 5 h, 80% (**D51**:**D54** = 2:1); (c) (MeO)<sub>2</sub>CMe<sub>2</sub>, TsOH, reflux, 1 h, 35% (**52**:**55** = 9:1); (d) as in (a), 60 °C, 88% (**D53**:**D56** = 1:1.3).

dimethoxypropane in the presence of *p*-toluene-sulfonic acid (TsOH), gave the diketal **52** as the major product. Similar results were observed for the diisopropylideneation of **D50**.<sup>43</sup>

The azide **D57**, on reaction with TIPDSCl<sub>2</sub> in pyridine, gave the 1,6-di-*O*-protected derivative **D59**;<sup>44</sup> the use of larger amounts of TIPDSCl<sub>2</sub> resulted in the formation of the tetra-*O*-protected derivative **D61** (Scheme 9). Similarly, C1- and C6-hydroxyl groups of **D58** could be protected using TIPDSCl<sub>2</sub>.<sup>25b</sup>

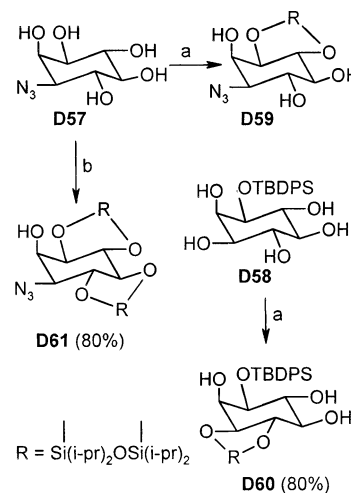
Scheme 9<sup>a</sup>

<sup>a</sup> (a) TIPDSCl<sub>2</sub> (1.2 equiv), pyridine, room temperature, 10 h; (b) TIPDSCl<sub>2</sub> (2.5 equiv), pyridine, 73 °C, 40 h.

Benzoylation<sup>25b,d,45</sup> of the silyl ether **D58** with 3 equiv of benzoyl chloride in pyridine provided the tribenzoate **D63**, while benzoylation with 1 equiv of benzoyl chloride gave the C3-benzoate **D64** as the major product. The use of 2 equiv of benzoyl chloride resulted in the formation of a mixture of benzoates, **D65** being the major product (Scheme 10). Silyla-

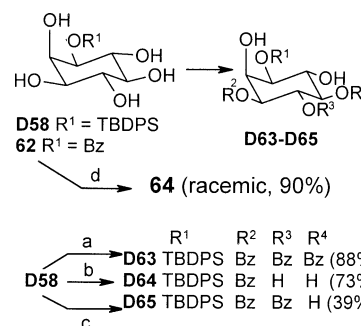
Scheme 10<sup>a</sup>

<sup>a</sup> (a) BzCl (3 equiv), pyridine, –10 °C; (b) BzCl (1 equiv), pyridine; (c) BzCl (2 equiv), pyridine; (d) TBDPSCl, imidazole, DMF.

tion<sup>45</sup> of **62** with *tert*-butyldiphenylsilyl chloride (TB-DPSCl) gave the racemic silyl ether **64** in very good yield (90%). Hence, it can be inferred that the observed selectivity in these reactions is independent of the pre-existing protecting group at the C1-*O* position.

Among the five hydroxyl groups in C3-*O*-protected *myo*-inositol derivatives, C1-OH seems to be the most reactive with electrophiles, and hence results in predominant formation of 1,3-di-*O*-protected deriva-

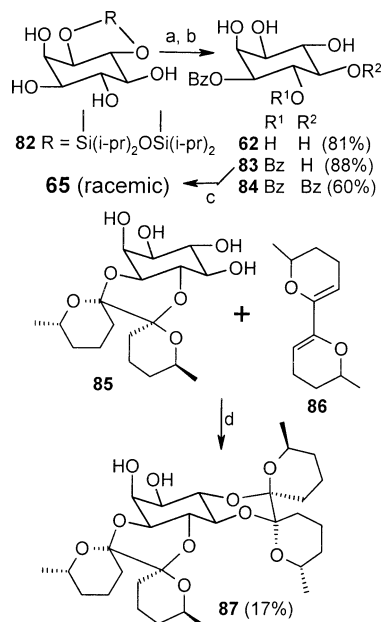

Scheme 14<sup>a</sup>

<sup>a</sup> (a) BzCl, pyridine; (b) HF, MeCN; (c) TBDPSCl, imidazole, DMF; (d) CSA, CHCl<sub>3</sub>.

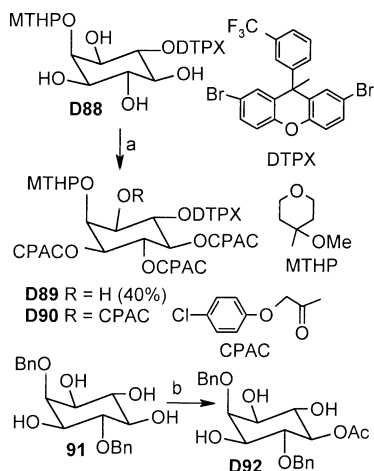
Scheme 15<sup>a</sup>

<sup>a</sup> (a) CPACCl, 1*H*-tetrazole, DMAP, MeCN, pyridine, room temperature; (b) lipase, vinyl acetate.

ture of the triester **D89** and the tetraester **D90**.<sup>38</sup> From these results, it is clear that the C1-OH is the least reactive among the four hydroxyl groups of **D88**. Lipase-catalyzed acetylation of racemic 2,4-dibenzyl ether **91** resulted in regio- and enantiospecific acetylation of the C5-OH, which was exploited for the preparation of both of the enantiomers of D-*myo*-inositol 1,3,4,5-tetrakisphosphate [Ins(1,3,4,5)P<sub>4</sub>].<sup>55</sup> Ketalization of **91** provided a mixture of monoketals, the 3,4-ketal being the major product.<sup>56</sup> These results are in contrast to the observed reactivity of most other inositol derivatives, wherein C1-OH is the most reactive. It appears that protection of the C2-OH group decreases the reactivity of the C3-OH group for reasons mentioned in section 2.2.2.

2.3.5. *myo*-Inositol-Based 1,3,4,6-Tetrols

As the 2,5-di-O-protected tetrols are symmetric, the reactivities of each pair of chemically equivalent

hydroxyl groups are the same. So, in principle, there are only two possible monosubstitutions and only one vicinal diol protection possible. The order of reactivity of hydroxyl groups cannot be predicted easily since C2-O substitution is known to reduce the reactivity of the C1(3)-OH group. There appear to be no reports on the monosubstitution of this class of tetrols in the literature. The question of regioselectivity does not arise during vicinal diol protection; however, diastereoselectivity has been achieved through vicinal diol protection with chiral bis-dihydropyrans.<sup>27,57</sup> D-1,2,5,6-Tetra-*O*-benzyl-*myo*-inositol [95% enantiomeric excess (ee)] has been prepared from 2,5-di-*O*-benzoyl-*myo*-inositol using a chiral bis-dihydropyran.<sup>58</sup> One of the pairs of vicinal hydroxyl groups in 2,5-di-*O*-benzyl-*myo*-inositol has been protected as the corresponding monoisopropylidene derivative.<sup>56</sup>

2.3.6. *myo*-Inositol-Based 1(3),4,5,6-Tetrols

Protection of 2,3-di-O-protected *myo*-inositol derivatives is of special interest since they have all trans-diequatorial vicinal diols. Most of the tetrols reported in the literature belonging to this category are 1,2(3)-ketals. Although C1(3)-OH appeared to be the most reactive during silylation,<sup>25b,59</sup> acylation,<sup>14a,25b,60</sup> and phosphorylation<sup>26</sup> of **26** and **D30**, relative yields of the products **93–D100** varied greatly (Scheme 16). In some cases, considerable

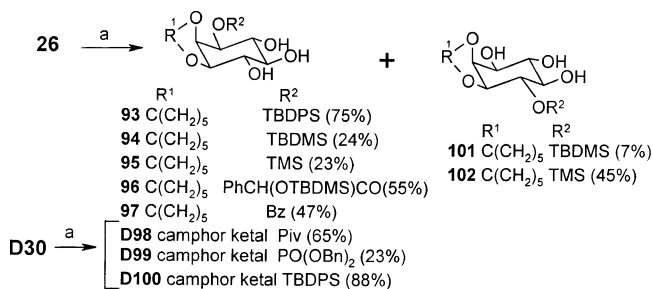
Scheme 16<sup>a</sup>

<sup>a</sup> (a) For detailed experimental conditions, see refs 14a, 25b, 59, and 60.

amounts of C4-OH-protected derivatives were also formed.<sup>25c</sup> However, it is clear that a sufficiently good distinction can be made between C1-OH and C4-OH with sterically hindered silylating and acylating agents such as TBDPSCl and pivaloyl chloride.

An exception to this general pattern of selectivity was observed during acetylation of racemic **26**, wherein acetylation<sup>61,62</sup> at the C4-O and C5-O positions occurred to yield a mixture of the corresponding C4- and C5-acetates. The reasons for this anomaly are not clear; but this could be a result of intramolecular acetyl migration since acetate groups are known to migrate with extreme facility among the hydroxyl groups of *myo*-inositol.<sup>63</sup>

It is interesting to note that the observed regioselectivity in the enzyme-assisted acylation<sup>14c,61</sup> of these tetrols (in organic solvents) depended on the source of the enzyme used. Acetylation of **26** in the presence of lipase CES (from *Pseudomonas* species) gave D-1,2-*O*-cyclohexylidene-3-*O*-acetyl-*myo*-inositol (and D-2,3-cyclohexylidene-*myo*-inositol) in 49% yield (98% ee), while acylation in the presence of other



lipases [porcine pancreatic lipase (PPL), *Candida cylindracea* lipase (CCL), and *Pseudomonas* species lipase (PSL)] resulted in regioselective and enantioselective acylation at the C5 position (of D-2,3-*O*-cyclohexylidene-*myo*-inositol). Use of cholesterol esterase gave equal amounts of C4- and C5-acetates (of D-2,3-*O*-cyclohexylidene-*myo*-inositol), while the use of subtilisin gave equal amounts of C5- and C6-esters of D-1,2-*O*-cyclohexylidene-*myo*-inositol. The presence of small amounts of water in the reaction mixture during lipase-mediated acylation, however, resulted in the migration of the acyl group to other free hydroxyl groups. In one of these studies,<sup>14c</sup> enzymes that gave high ee resulted in low yield of the product, while those that gave high yield gave low ee.

Diprotection of 1,2-ketals<sup>24,25b,64,65</sup> resulted in the formation of 3,6-di-*O*- or 3,5-di-*O*-protected derivatives (Scheme 17). Experimental conditions for the isolation of the dibenzyl ether **104** by crystallization have been reported.<sup>24</sup>

### Scheme 17<sup>a</sup>

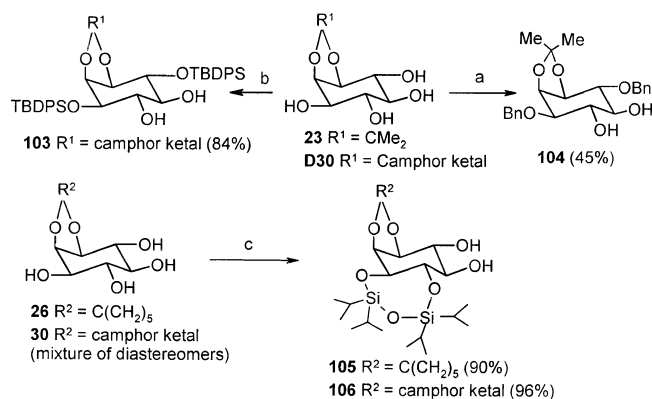

<sup>a</sup> (a) Bu<sub>2</sub>SnO, Bu<sub>4</sub>NBr, MeCN, BnBr; (b) TBDPSCl, imidazole, pyridine; (c) TIPDSCl<sub>2</sub>, pyridine, room temperature.

The cyclohexylidene derivative **26**, on treatment with 1 equiv of TIPDSCl<sub>2</sub> in pyridine at ambient temperature, gave the 5,6-diol **105** in very good yield.<sup>28</sup> Similarly, regioselective bisprotection of a mixture of all four diastereomers of monocamphor ketal derivatives of *myo*-inositol with TIPDSCl<sub>2</sub> gave a mixture of all the 5,6-diols of general formula **106** (Scheme 17).<sup>25b</sup> Formation of **105** and **106** is clearly the result of initial silylation of the C1(3)-OH followed by cyclization with C6(4)-OH. If the initial silylation was at the C6(4)-OH, in principle this must have resulted in the formation of two products, due to cyclization with C1(3)- and C5-hydroxyl groups.

Dibutyltin oxide-mediated trialkylation of **23**<sup>64</sup> and **26**<sup>66</sup> led to a mixture of 1,4,5- and 1,4,6-tri-*O*-alkylated derivatives in a 1:1 ratio (Scheme 18). Alkylation resulting in the formation of 1,5,6-tri-*O*-substituted derivatives was not observed. As dialkylation gives the 1(3),4(6)-di-*O*-alkylated product (see above), it is obvious from the product distribution that there is no selectivity among C5- and C6(4)-hydroxyl groups for the third alkylation in this class of tetrols. Acylation of a camphor ketal derivative of *myo*-inositol with 3 equiv of pivaloyl chloride resulted in *O*-substitution predominantly at the 1,4,5-positions.<sup>65</sup>

### Scheme 18<sup>a</sup>

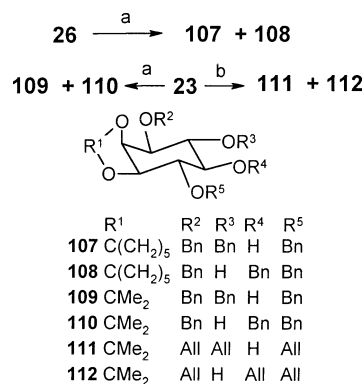

<sup>a</sup> (a) Bu<sub>2</sub>SnO, Bu<sub>4</sub>NBr, BnBr; (b) Bu<sub>2</sub>SnO, Bu<sub>4</sub>NBr, MeCN, AllBr.

From these results, it is clear that, during mono-protection of 1,2-*O*-protected *myo*-inositols, C3-*OH* and, during diprotection, C3- and C6-*OH* are preferentially protected; both C4- and C5-*OH* have similar reactivity. Thus, largely, the order of reactivity of hydroxyl groups in 1,2-*O*-protected *myo*-inositol derivatives is C3 > C6 > C4 ~ C5. It appears that, in this class of tetrols, the selectivity pattern varies slightly when 1,2-positions are protected by groups other than ketals.<sup>60c</sup> However, a comparison of the reactivity and the observed selectivity pattern of this class of tetrols, with tetrols where C1- and C2-*OH* are free suggests that protection of the C2-*OH* group results in reduced reactivity of the C1-*OH* group. This supports the suggestion that the higher reactivity of C1-*OH* group in *myo*-inositol and its derivatives could be a result of intramolecular hydrogen bonding between the C1- and C2-*OH* groups.

## 2.4. Regioselective Protection of *myo*-Inositol-Based Triols: Selectivity among Three Hydroxyl Groups

### 2.4.1. *myo*-Inositol-Based 1(3),2,5-Triols

The bis-silyl ether **D113**, on phosphorylation with the phosphite **114**, resulted in the formation of the 1-phosphate **D115** (Scheme 19) in a completely regioselective manner<sup>67</sup> without affecting the hydroxyl groups at the C2 and C5 positions.

### Scheme 19<sup>a</sup>

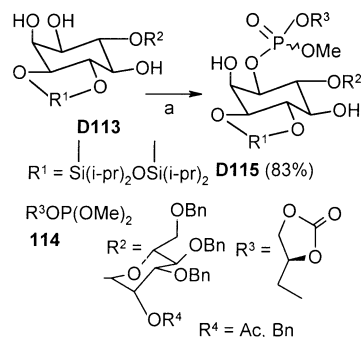

<sup>a</sup> (a) **114**, pyridinium bromide perbromide, Et<sub>3</sub>N.

### 2.4.2. *myo*-Inositol-Based 1(3),2,6(4)-Triols

Silylation<sup>45</sup> of **84** and alkylation<sup>68</sup> of **116** yielded the corresponding 1-*O*-substituted derivatives (race-

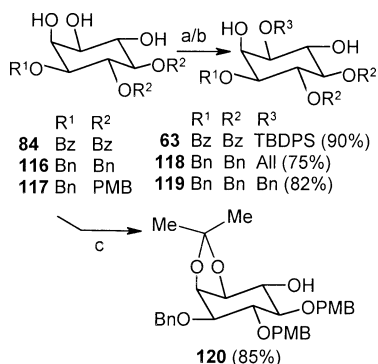
Scheme 20<sup>a</sup>

<sup>a</sup> (a) TBDPSCl, imidazole, DMF; (b) Bu<sub>2</sub>SnO, benzene, reflux; AllBr or BnBr, Bu<sub>4</sub>NI, 70 °C; (c) 2,2-dimethoxypropane, acetone, TsOH, 72 h.

mic **63**, **118**, and **119**) predominantly (Scheme 20). The triol **117**, on reaction with 2,2-dimethoxypropane, yielded the corresponding 1,2-ketal **120**, as expected.<sup>69</sup> The regioselectivity observed in these reactions is due to the enhanced nucleophilicity of the C1-OH, as mentioned earlier (section 2.2.2).

2.4.3. *myo*-Inositol-Based 1,3,5-Triols

The triol **121** was regioselectively benzylated at the C1- or C3-O position (1:1) under phase-transfer catalysis (PTC) conditions.<sup>70</sup> Miller et al.<sup>71</sup> developed peptide-based catalysts for the asymmetric phosphorylation of the triol **122** and synthesized D- and L-Ins-(1)P in good overall yields. Triol **122**, on dibenzoylation,<sup>72</sup> gave the dibenzoate **125** in good yield. Thus, alkylation, acylation, or silylation<sup>28d</sup> of 1,3,5-triols predominantly leads to reaction at the C1-O and C3-O positions, even though the C2-OH group is protected (see next section). Use of 1 equiv of the reagent gives a mixture of 1-O- and 3-O-substituted products (in asymmetrically substituted derivatives), while the use of an excess of the reagent gives the 1,3-di-O-substituted derivatives (Scheme 21). These

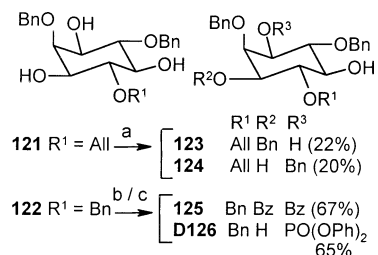
Scheme 21<sup>a</sup>

<sup>a</sup> (a) Bu<sub>4</sub>NBr, BnBr, aqueous NaOH, CH<sub>2</sub>Cl<sub>2</sub>, 16 h; (b) BzCl, pyridine; (c) peptide catalyst, ClP(O)(OPh)<sub>2</sub>.

results show that, among the three hydroxyl groups, C5-OH is the least reactive. The enhanced nucleophilic reactivity of C1- and C3-OH toward electrophiles has been attributed to the through-space α-effect<sup>73</sup> caused by the cis-related C2-oxygen.

2.4.4. *myo*-Inositol-Based 1,3,(4)6-Triols

Reaction of the triol **67** (Scheme 11) with DtpxCl (Scheme 15) in the presence of pyridine yielded the corresponding C6-ether as the major product.<sup>38</sup> The selectivity observed again shows that the reactivity

of C1-OH is reduced on O-substitution at the C2 position (section 2.2.2). These intermediates, containing solely acid-labile and base-labile protecting groups, were used for the synthesis of phosphatidylinositols (PtdIns). The use of benzyl and related protecting groups that are removable by hydrogenolysis was avoided, since naturally occurring PtdIns have olefinic double bonds in the arachidonoyl residue which are susceptible to catalytic hydrogenation.

2.4.5. *myo*-Inositol-Based 2,4,6-Triols

The 2,4,6-triols most frequently used for the synthesis of phosphoinositols and other derivatives of cyclitols are the *myo*-inositol 1,3,5-ortho esters, since large quantities can easily be obtained in a short time. Since formation of *myo*-inositol 1,3,5-ortho esters involves flipping of the carbocyclic ring, these ortho esters have one equatorial oxygen and five axially disposed oxygens. Due to the rigid adamantane-like structure of these ortho esters, and due to the presence of two equivalent 1,3-diaxial hydroxyl groups, they can be chemically distinguished from the third equatorial hydroxyl group. As a result, methods for the selective protection of (a) C2-OH, (b) C4-OH, and (c) C2-OH and C4-OH simultaneously, as well as (d) C4-OH and C6-OH simultaneously, have been developed.

C2-OH in these triols can be protected (Scheme 22) by silylation,<sup>31,74</sup> acylation (in pyridine<sup>35f</sup> or in the

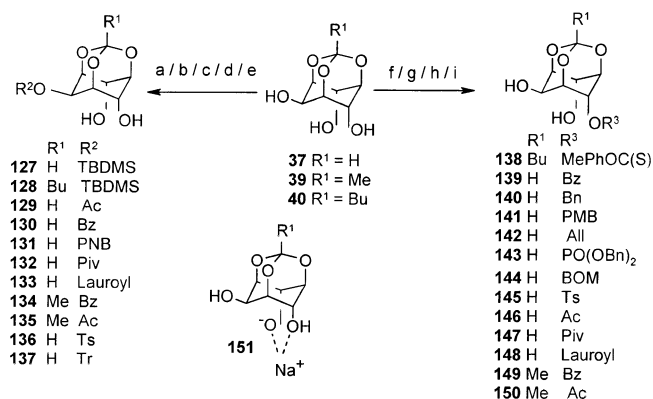
Scheme 22<sup>a</sup>

<sup>a</sup> (a) TBDMSCl, imidazole; (b) BzCl, pyridine; (c) acyl chloride/anhydride, NaH (2 equiv); (d) TsCl, pyridine; (e) trityl chloride, NEt<sub>3</sub>; (f) acyl chloride/anhydride, NaH (1 equiv); (g) TsCl, NEt<sub>3</sub>; (h) alkyl halide, NaH; (i) tetrabenzylpyrophosphate, NaH.

presence of 2 equiv of sodium hydride<sup>75</sup> or lipase<sup>35c</sup>), sulfonylation,<sup>76</sup> and tritylation.<sup>77</sup> Experimental conditions for the acylation,<sup>37,75</sup> sulfonylation,<sup>76</sup> alkylation,<sup>35b,78</sup> and phosphorylation<sup>35b</sup> of the C4(6)-OH exclusively have also been developed. The high degree of regioselectivity observed for alkylation,<sup>35b,78</sup> acylation,<sup>75</sup> and sulfonylation<sup>76</sup> of this class of triols in the presence of metal hydrides, resulting in the formation of 4-O-protected derivatives, has been attributed to the chelation effect (**151**).<sup>35b,76b</sup> Tosylation of *myo*-inositol ortho esters is particularly interesting, since it allows the preparation of any monotosyl or ditosyl derivatives (of **37** and **39**, see below). Although sulfonates are generally not used as hydroxyl protecting groups, due to the difficulty

in regenerating the parent hydroxyl group, it is possible to use them for the protection of hydroxyl groups of *myo*-inositol ortho esters due to their rigid adamantane-like structure, which allows the cleavage of sulfonates with retention of (*myo*-) configuration.<sup>76</sup>

A careful comparison of the results on monoacylation of the triol **37** under different reaction conditions reveals that the regioselectivity can be controlled by changing the acylating agent and/or the base used.<sup>79</sup> For instance, the use of benzoic anhydride as the acylating agent is reported<sup>79b</sup> to give the C4-benzoate **139** as the major product, while the use of benzoyl chloride gave different products, depending on the base used. The use of benzoyl chloride with pyridine as the base gave the C2-benzoate **130**, while the use of triethylamine<sup>79a</sup> as the base gave the C4-benzoate **139** (Scheme 22). In pyridine, benzoyl chloride forms an intermediate benzoyl pyridinium ion, which is both highly reactive and sterically hindered. The acylation reaction takes place through a transition state where the hydroxyl group is mostly un-ionized, and hence the selectivity is thought to be governed by steric factors.<sup>79b</sup> In contrast, with the less reactive benzoic anhydride, the acylation proceeds via the previous activation of the hydroxyl group (by Et<sub>3</sub>N) in the form of an intermediate alkoxide anion and leads to acylation at the C4-O position. Acylation of these triols in the presence of 1 equiv of sodium hydride gave the C4-ester, while the use of 2 equiv of sodium hydride gave the C2-ester. These results could be explained on the basis of a chelation-assisted acylation and acyl migration.<sup>75</sup> From these results, it is clear that, by and large, reaction of *myo*-inositol 1,3,5-ortho esters with electrophiles in the presence of stronger bases results in substitution at the C4-(6)-O position, while in the presence of weaker bases (pyridine, imidazole) the substitution is at the C2-O position.

Acylation of *myo*-inositol ortho esters with 2 equiv of acyl chloride yields the corresponding unsymmetrical diesters<sup>80</sup> (Scheme 23). This has been uti-

#### Scheme 23<sup>a</sup>

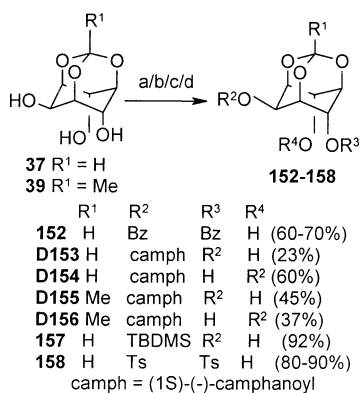

<sup>a</sup> (a) Pyridine, BzCl (2.5 equiv), 0 °C to room temperature, 16 h; (b) camphCl, DMAP, CH<sub>2</sub>Cl<sub>2</sub>, Et<sub>3</sub>N; (c) TBDMSCl (2 equiv), imidazole, DMF, room temperature; (d) TsCl (2 equiv), pyridine or Et<sub>3</sub>N, DMF, room temperature.

lized for the desymmetrization of ortho esters **37**<sup>81</sup> and **39**<sup>34a</sup> as their dicamphanates (**D153**–**D156**) during the synthesis of Ins(1,3,4,5)P<sub>4</sub> and Ins(1,4,5)-

P<sub>3</sub>. Silylation<sup>82</sup> of **37** with 2 equiv of TBDMSCl is also reported to give the unsymmetrical disilyl ether **157**. Recently, we developed a method<sup>76</sup> for the ditosylation of ortho esters of **1** to obtain the unsymmetrical ditosylate **158**. Conditions for the simultaneous protection of C2-OH and one of the axial hydroxyl groups (C4 or C6) as ethers has not been developed yet for these ortho esters.

Although attempts were made to prepare symmetrical di-O-protected derivatives **159**,<sup>35b</sup> **160**,<sup>83</sup> and **161**,<sup>84</sup> most of them resulted in poor isolated yields. During our study on regioselective sulfonylation reactions of *myo*-inositol 1,3,5-ortho esters, we developed a method<sup>76,85</sup> to obtain the symmetrical ditosylate **162** in good yield (Scheme 24). Formation

#### Scheme 24<sup>a</sup>

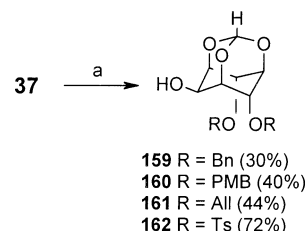

<sup>a</sup> (a) DMF, NaH (2 equiv), RX (2 equiv), X = Cl, Br.

of the symmetrical derivatives **159**–**162** as major products in the presence of sodium hydride has been attributed to chelation of Na<sup>+</sup> (similar to **151**), which stabilizes the alkoxide at C4, as compared to the alkoxide at the C2 position, during the second substitution (for example, in **145**).

There are two possible routes for the formation of 2,4-di-O-substituted derivatives of *myo*-inositol ortho esters. Which of these routes will be followed preferentially depends on the initial formation of a monosubstituted derivative. All the possibilities are shown in Scheme 25.

#### Scheme 25

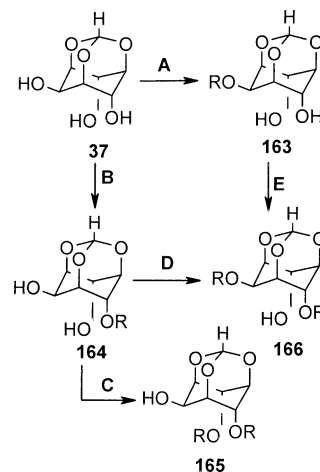

Diacylation of *myo*-inositol ortho esters in the presence of pyridine proceeds via route A,E. This does not lead to a mixture of isomers, since C2-O-substituted derivatives **163** are symmetric. Since alkylation of the *myo*-inositol ortho esters needs the presence of a strong base (e.g., sodium hydride), dialkylation proceeds via routes B,C and B,D to give a mixture of isomeric diethers **165** and **166**. However,

the diaxial diethers **165** are formed in larger amounts. Di-*O*-sulfonylation of triols is dependent on the base and the solvent used for the reaction. Sulfonylation in the presence of pyridine or triethylamine gives the 2,4-di-*O*-sulfonyl derivatives via routes **A,E** and **B,D** respectively, while the presence of strong bases (NaH) leads to predominant formation of 4,6-di-*O*-sulfonyl derivatives **165** (via routes **B,C**).

The different regioselectivities observed (Schemes 22–24) for the acylation of the triols **37** and **39** have been attributed to one or a combination of the following factors: (a) The presence of intramolecular hydrogen bonding<sup>86</sup> between the C4- and C6-OH groups increases the acidity of one of them and stabilizes the anion formed in the presence of strong bases. The increased acidity of one of the axial hydroxyl groups is evidenced by (i) a higher chemical shift for the axial hydroxyl groups in the <sup>1</sup>H NMR spectrum of the triol **37** as compared to that of the equatorial hydroxyl group; (ii) alkylation of one of the axial hydroxyl groups in the presence of potassium carbonate<sup>87</sup> (which is not possible for normal alcohols); (iii) glycosylation of **37**<sup>86</sup> and its analogues<sup>36,74a</sup> with carbohydrate-derived diazirenes; and (iv) the X-ray crystal structure of **37**.<sup>86</sup> (b) Stabilization of the axial alkoxide by a metal ion due to its chelation with the other cis-axial oxygen atom. (c) The lesser probability of formation of an equatorial alkoxide anion, due to electron pair repulsion with the lone pair of electron on the C1 and C3 oxygens.<sup>79b</sup> (d) Higher nucleophilicity of the C2-OH (as compared to the axial hydroxyl groups) due to its lower acidity. (e) 1,3-Diaxial steric interactions, especially during acylation with bulky reagents (e.g., pyridine/benzoyl chloride, where the acylating species is the benzoyl pyridinium ion). Factors (a), (b), and (c) above contribute toward predominant substitution of the C4- or C6-OH groups, while factors (d) and (e) facilitate the reaction at the C2-OH. The final outcome of a reaction seems to be dependent on an interplay between these factors, which are governed by the reaction conditions and the reagent used. The observed selectivity for the acylation<sup>35c</sup> of *myo*-inositol ortho esters in the presence of lipases cannot be rationalized with the existing data in the literature, since not much is known about the interaction between the enzyme and the substrates.

The tribenzoate **167**, on coupling with 2,3-*O*-protected alkyl hydrogen tartrates, afforded both diastereomeric monotartrates **D168** and **D169** (Scheme 26) in moderate yield.<sup>88</sup> The diastereoselectivity was dependent on the protecting groups in the chiral acylating agent. No acylation was observed at the C2-*O* position, perhaps due to the steric hindrance of the substituents at C1 and C3 positions for reaction at the C2-OH.

#### 2.4.6. *myo*-Inositol-Based 4,5,6-Triols

Pivaloylation<sup>25b</sup> or silylation<sup>25b,60a</sup> of 4,5,6-triols yields the corresponding 4-*O*-protected derivatives selectively in good yield (Scheme 27). However, monobenzylation of **D100** lacked selectivity and yielded a mixture of the corresponding mono- and dibenzoates.<sup>25d</sup> Dibenzoylation, on the other hand,

#### Scheme 26<sup>a</sup>

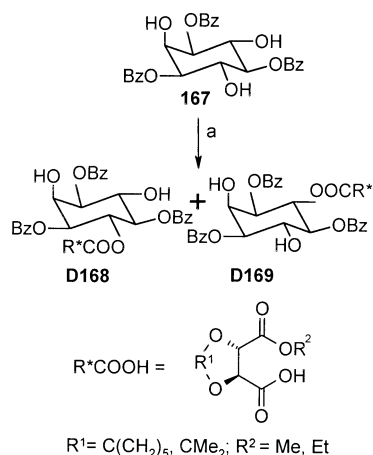

<sup>a</sup> (a) R\*COOH, MeSO<sub>2</sub>Cl, DMAP, *N*-methylmorpholine, THF, 0 °C.

#### Scheme 27<sup>a</sup>

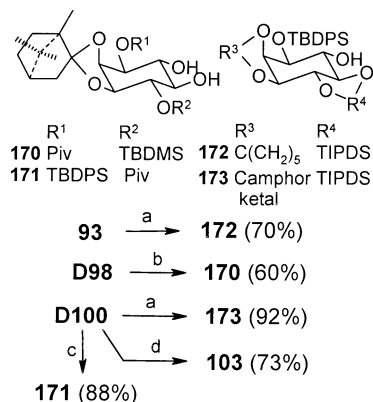

<sup>a</sup> (a) TIPDSCl<sub>2</sub>, pyridine, room temperature; (b) TBDMSCl (1.2 equiv), DMF, Et<sub>3</sub>N, DMAP, -20 °C; (c) PivCl, pyridine, -10 °C; (d) TBDPSCl, imidazole, pyridine.

proceeded with good regioselectivity to yield the corresponding 4,5-dibenzoates in 90% yield.<sup>25d</sup> Silylation<sup>14a,25b,89</sup> with TIPDSCl<sub>2</sub> resulted in the formation of 4,5-*O*-bis-silyl ether (**172** or **173**), which is a consequence of the initial reaction at the C4-OH.

## 2.5. Regioselective Protection of *myo*-Inositol-Based Diols: Selectivity among Two Hydroxyl Groups

Most of the reports on the selective protection of this class of *myo*-inositol derivatives involve ketals. Due to the conformational rigidity imposed on the inositol ring by cyclic ketals, protection of the remaining free hydroxyl groups can be selectively manipulated under suitable conditions. However, there have been few systematic investigations on the origin of the differential reactivities of the hydroxyl groups in these compounds.

### 2.5.1. *myo*-Inositol-Based 1(3),2-Diols

Acylation,<sup>5j,14e,f,25b,90</sup> sulfonylation,<sup>91</sup> silylation,<sup>92</sup> alkylation<sup>4e,9b,18b,19c,48a,69,90f,93</sup> and phosphorylation<sup>9d,94</sup> of 3,4,5,6-tetra-*O*-substituted *myo*-inositol derivatives gave the corresponding C1-*O* derivative as the major product (65–95%), irrespective of the protecting groups present in the diols (Scheme 28). In some

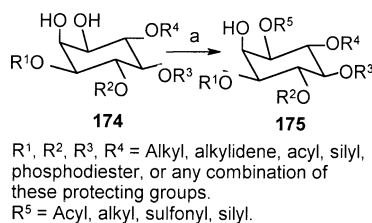
Scheme 28<sup>a</sup>

<sup>a</sup> (a)  $R^5X$  ( $X = \text{Cl, Br}$ ), base.

experiments, small amounts of 1,2-di-O-substituted derivatives were also obtained. The selectivity observed is as expected, since C1-OH, being in the equatorial position, is more reactive and the resulting products are thermodynamically stable. From these results, it appears that the conformation of the carbocyclic ring does not deviate much (from the chair form) with variation of the protecting groups in 1,2-diols. Many *myo*-inositol-based 1,2-diols have been resolved as their diastereomers via esterification with chiral acylating agents.<sup>28,51,88,95</sup> In all the cases, a mixture of diastereomeric C1- and C3-esters was predominantly formed. Selectivities observed during the benzylation of 1,2-diols of 3-deoxy-*myo*-inositol<sup>43</sup> and 3-deoxy-3-halo derivatives<sup>40,41,90e</sup> were similar to those observed for the acylation of tetra-O-protected *myo*-inositol derivatives. Oxidation of racemic **174** ( $R^1 = R^2 = R^3 = R^4 = \text{Bn}$ ) via its stannylene derivative led to the oxidation of the C2-OH predominantly to afford the corresponding ketone.<sup>96</sup>

2.5.2. *myo*-Inositol-Based 1(3),4(6)-Diols

The diisopropylidene derivative **25** and the dicyclohexylidene derivative **28** showed similar reactivities toward alkylation,<sup>19d,48b,c,f,97</sup> acylation,<sup>95b,97f,98</sup> sulfonylation,<sup>97f,99</sup> silylation,<sup>97f,100</sup> and phosphorylation.<sup>97f,h-i</sup> Both **25** and **28** gave the corresponding C1-O-substituted derivative as the major product (Scheme 29), but isolated yields (30–75%) of these products were much less than those obtained in the case of 1,2-diols. This observed decrease in the selectivity for C1-O substitution is in accordance with the results reported for the reaction of other C2-O-protected *myo*-inositol derivatives (section 2.2.2).

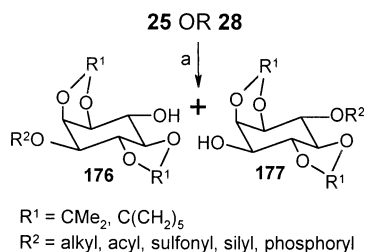
Scheme 29<sup>a</sup>

<sup>a</sup> (a) Alkylation or acylation or sulfonylation or silylation or phosphorylation; for details, see references cited in text.

The observed selectivity during the benzylation<sup>95b</sup> of **28** was dependent on the reagent and the reaction conditions used. Among benzoyl chloride, benzoic anhydride, and benzoyl imidazole, the last reagent gave the best result; in other cases, a significant amount of the C4-benzoate **177** ( $R^1 = \text{C}(\text{CH}_2)_5, R^2 = \text{Bz}$ ) was also formed. Aneja et al.<sup>97g</sup> reported a

selective mono-allylation at C1-OH of **28** by treatment with allyl bromide in DMF and gradual addition of sodium hydride to provide kinetic control, which resulted in a higher yield of **176** ( $R^2 = \text{allyl}$ ). A combination of barium oxide and barium hydroxide has been used for the benzylation of **28** to obtain the corresponding C1-benzyl ether in 70% yield.<sup>101</sup> It is of interest to note that this method did not lead to the formation of the C4-benzyl ether, as observed in sodium hydride-assisted benzylation of **28**.

A study of the crystal structure<sup>97f,102</sup> of **25** showed that the C1-OH is more sterically hindered than C4-OH, owing to the proximity of the adjacent *cis*-2,3-*O*-isopropylidene ring. This result does not correlate with the experimentally observed fact that C1-OH is more reactive than C4-OH in **25**. Hence, the difference in the reactivity of the hydroxyl groups in **25** does not appear to be due to steric effects. The observed differences in relative reactivities of the hydroxyl groups in **25** have also been evaluated using semiempirical<sup>103</sup> and quantum mechanical<sup>73</sup> calculations. It appears that the observed increased reactivity of the C1-OH as compared to the C4-OH in these diketals could be due to the following reasons: (a) increased kinetic acidity of the C1-OH through its intramolecular hydrogen bonding with the *cis*-vicinal oxygen at C2 and (b) enhancement in the nucleophilicity of the C1-alkoxide due to its interaction with the *cis*-vicinal oxygen in a manner similar to the through-space  $\alpha$ -effect.<sup>104</sup> In the structurally similar dicyclohexylidene diol **28**, the inositol ring adopts a distorted chair conformation. The conformation of the inositol ring is qualitatively consistent with that observed in solution by NMR spectroscopy, which suggests that the observed relative reactivity of the two hydroxyl groups in **28** cannot be attributed to the differences in their acidity or steric effects.<sup>103</sup>

2.5.3. *myo*-Inositol-Based 1(3),5-Diols

2,3,4,6-Tetra-O-substituted *myo*-inositol derivatives, on acylation,<sup>105a,d</sup> alkylation,<sup>94c</sup> and phosphorylation,<sup>94c</sup> preferentially yielded the corresponding 1-O-substituted products (Scheme 30), as observed in the case of other *myo*-inositol-derived 1,*n*-diols (in which either C1-OH or C3-OH is not protected).

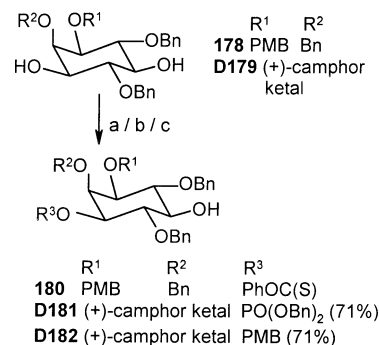
Scheme 30<sup>a</sup>

<sup>a</sup> (a) PhOCSCl (2.6 equiv), DMAP, MeCN, 0 °C, 60 h; (b) (i) (*i*-Pr)<sub>2</sub>NP(OBn)<sub>2</sub>, 1*H*-tetrazole, CH<sub>2</sub>Cl<sub>2</sub>, 23 °C, 2 h; (ii) *m*-CPBA, -40 °C, 1 h; (c) (i) Bu<sub>2</sub>SnO, benzene, reflux, 6 h; (ii) PMBCl, CsF, DMF, 23 °C, 12 h.

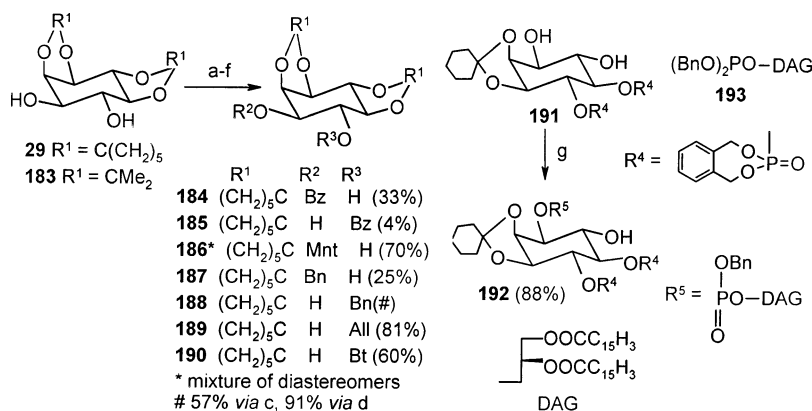
Scheme 31<sup>a</sup>

<sup>a</sup> (a) BzCl, pyridine, 18 h; (b) Bu<sub>2</sub>SnO, PhMe, MntCl, NaHCO<sub>3</sub>; (c) 5% aqueous NaOH, Bu<sub>4</sub>NHSO<sub>4</sub>, BnBr, CH<sub>2</sub>Cl<sub>2</sub>, reflux; (d) Bu<sub>2</sub>SnO, BnBr, CsF, DMF; (e) Bu<sub>2</sub>SnO, PhMe, reflux then DMF, AllBr; (f) Bu<sub>2</sub>SnO, PhMe, reflux; BtCl, CsF, DMF; (g) **193**, 2,6-lutidine, pyridinium tribromide, -45 to 0 °C, 1.5 h.

2.5.4. *myo*-Inositol-Based 1(3),6(4)-Diols

Regioselectivity during acylation<sup>19a,104,105b,c</sup> and alkylation<sup>19c,93k,104,106</sup> of this group of diketal diols (Scheme 31) was dependent on the reaction conditions used. Benzoylation<sup>19a</sup> of **29** with benzoyl chloride in pyridine gave the corresponding C1-benzoate **184** as the major product. Acylation of **183** (below ambient temperature) with pivaloyl chloride was much more selective (81%) toward the C1-OH, and the product could be isolated by crystallization from hexane.<sup>104</sup> However, pivaloylation over an extended period at room temperature resulted in poor selectivity, perhaps due to the base-catalyzed isomerization of the product (as indicated by TLC) involving the vicinal trans-hydroxyl group. Schmidt et al.,<sup>105b</sup> during the synthesis of *D-erythro*-ceramide-1-phosphoinositol, resolved racemic **29** by regioselectively converting it to two diastereomers of C1(3)-*O*-menthylloxycarbonyl derivative **186** via the tin-mediated esterification reaction. During the synthesis of Ins-(1,3,4,5)P<sub>4</sub>, Chen<sup>105c</sup> selectively butyrylated **29** at its 6-O-position via the stannylene derivative. Alkylation with *p*-methoxybenzyl chloride (PMBCl) resulted in the formation of only the C6-benzyl ether.<sup>107</sup> From the results in Scheme 31, it is obvious that stannylene-mediated alkylation or acylation results in the formation of 6-O-substituted derivative (except in the case of **186**), whereas acylation in pyridine yields the 1-O-substituted derivative. The reaction via the stannylene method occurs at C6-OH, perhaps because of the attack of the electrophile on the stannylene intermediate from the less hindered side.

The relative reactivity of the two hydroxyl groups in **183** was similar to that of the corresponding cyclohexylidene derivative. Benzoylation of **183** in the presence of sodium hydride in DMF proceeded with poor regioselectivity. The observed selectivity (for the reaction at C1-OH) could, however, be increased by using toluene instead of DMF as the solvent.<sup>104</sup> The observed large regioselectivity difference in benzylation resulting from a change of solvent could be due to the reactivity difference of the alkoxide in the two solvent systems (DMF/toluene) rather than conformational changes accompanying the solvent change. This is suggested by a comparison of the <sup>1</sup>H NMR

spectra of **183** in CDCl<sub>3</sub> and DMSO-*d*<sub>6</sub>. The selectivity of hydroxyl group protection could be reversed by carrying out the benzylation via the stannylene derivative.<sup>104,106a,b,d</sup> Thus, selective protection of either of the hydroxyl groups in 1,6-diols can be achieved by choosing appropriate reaction conditions.

The diol **183** has a twist-boat (skew) conformation in its crystal, and it appears to be an equilibrium mixture of chair and twist-boat in solution.<sup>104</sup> The crystal structure of **183** revealed that the C1-OH is more sterically hindered than the C6-OH, owing to the proximity of the adjacent *cis*-isopropylidene ring. This result does not correlate with the fact that the C1-OH is more reactive than the C6-OH, as in the case of **25** (section 2.5.2). Thus, the observed differences in reactivity could not be accounted for on the basis of steric effects.<sup>102</sup> Hence, the observed regioselectivity during the protection of *myo*-inositol-derived 1,6-diols (**29** or **183**) might be traced to the following factors: (a) the enhanced reactivity of the C1-OH could be due to its higher acidity, potentially involving the vicinal oxygens as intermediate bases; (b) cation chelation between the alkoxide anion generated and the *cis*-vicinal ether oxygen [such a cation chelation effect has been invoked to explain the regioselectivity during the alkylation of the orthoformate **37** (section 2.4.5)]; (c) through-space interaction between the alkoxide anion and the *cis*-vicinal ether oxygen, which could enhance the nucleophilicity of the alkoxide.<sup>104</sup> Protection of *myo*-inositol-based 1,6-diols other than diketals, by alkylation,<sup>48b,57c,93f,108</sup> acylation,<sup>93f,109</sup> or phosphorylation,<sup>110</sup> resulted in the predominant protection of the C1-OH group, but the

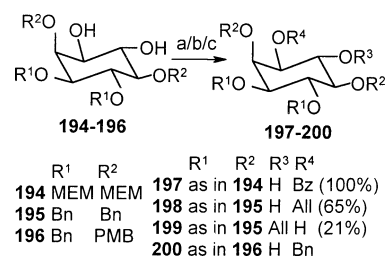
Scheme 32<sup>a</sup>

<sup>a</sup> (a) BzCl, pyridine, -30 °C; (b) Bu<sub>2</sub>Sn(OMe)<sub>2</sub>, PhMe, AllBr, Bu<sub>4</sub>NI; (c) Bu<sub>2</sub>SnO, BnBr.

isolated yield of the C1-O derivative varied. These results seem to indicate that the instances of enhanced reactivity of the C6-OH group (as compared to the C1-OH group) in diketals (see above) could be mainly due to the conformational changes in the carbocyclic ring induced by the presence of two ketals. Thus, the relative reactivity of the two hydroxyl groups of 1,6-diols seems to vary, depending on the nature of the other protecting groups present in the inositol derivative. Although the observed relative reactivity of the hydroxyl groups can be rationalized, it is difficult to pinpoint exact reasons, and hence to predict the outcome of a reaction.

### 2.5.5. *myo*-Inositol-Based 2,4(6)-Diols

A detailed investigation<sup>68</sup> on the alkylation and acylation<sup>88</sup> of 2,4-diols revealed that (Scheme 33)

#### Scheme 33<sup>a</sup>

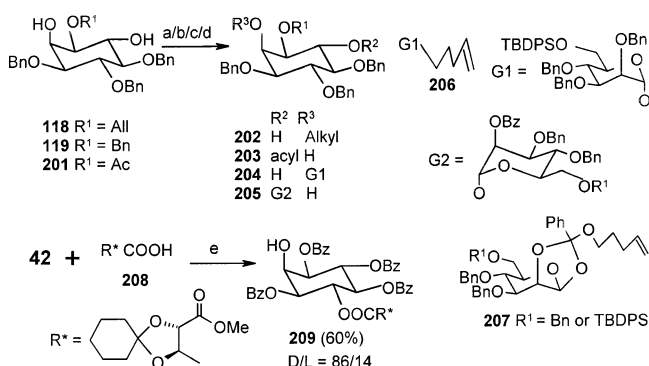

<sup>a</sup> (a) Alkylation; (b) acylation; (c) **206**, NIS (1.3 equiv), TBDMSOTf (catalytic), CH<sub>2</sub>Cl<sub>2</sub>, 10 min; (d) **207**, as in (c), 0 °C, 20 min; (e) MsCl, *N*-methylmorpholine, DMAP, THF, 0 °C.

alkylation preferentially occurred at the C2-O position, while acylation occurred at the C4-O position. It appears that chelation of the metal ion with 1,2-cis oxygens could result in predominant reaction at the axial C2-OH, while the inherent higher reactivity of the equatorial C4-OH prevails during acylation in the absence of metal hydrides. No reports on the acylation of these diols in the presence of metal hydrides are as yet available to verify this line of thought.

Regioselectivity during glycosylation<sup>68c,111</sup> of **119** with *n*-pentenyl glycosides **206** and ortho esters **207** was dependent on the glycosylating agent. This site-selective glycosylation is of interest as C2 and/or C6 mono- and diglycosylated inositols occur in GPIs and lipoarabinomannans (LAMs), the biological “warheads” of malaria and tuberculosis cell–surface oligosaccharides, respectively.

The unsymmetrical diols (Scheme 34) obtained from *myo*-inositol 1,3,5-ortho esters, on acylation<sup>35d,86</sup> or silylation<sup>34b,36,74</sup> in the presence of mild bases, gave the corresponding C2-O-protected derivatives. Benzoylation under acidic conditions<sup>35a</sup> gave the C2-ether, while the use of PTC or sodium hydride for benzylation yielded a mixture of both C2- and C4-ethers.<sup>35b</sup> In the case of PTC reaction,<sup>35a</sup> the C2-ether was the major product, while the use of sodium hydride gave the C4-ether as the major product. Preferential formation of the diaxial diether in the presence of

#### Scheme 34<sup>a</sup>

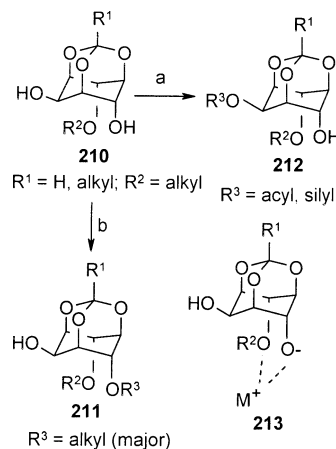

<sup>a</sup> (a) Acylation or silylation; (b) R<sup>3</sup>X, NaH.

metal hydride could be a result of the stabilization of the axial anion due to chelation of the metal ion (**213**, see section 2.4.5). The absence of such stabilization for the anion during the PTC reaction or non-formation of anions during the acid-catalyzed reaction could have resulted in the predominant formation of the C2-O-substituted derivatives in the absence of metal ions. The reactivities of the C2-OH and C4-OH groups in 4-deoxy and 4-fluoro analogues<sup>34b,36,74</sup> of *myo*-inositol ortho esters were similar to those mentioned above.

### 2.5.6. *myo*-Inositol-Based 2,5-Diols

Different regioselectivities have been observed during the O-substitution of 2,5-diols, perhaps due to the nature of protecting groups present in these derivatives. Glycosylation of the diastereomer **D115**<sup>67</sup> (Scheme 19) resulted in the predominant reaction at the C2-OH, while phosphorylation of the bis-silyl ether **34** (Scheme 5) yielded the corresponding 5-phosphate.<sup>112</sup> The latter example suggests that, when C2- and C5-OH have similar environments, O-substitution occurs at the equatorial C5-OH, as the two cis protecting groups offer steric hindrance for the reaction at C2-OH. This has been exploited for a concise synthesis of *neo*-inositol starting from **1**.<sup>28b,c</sup> The reason for the opposite selectivity in **D115** may be the masking of the C5-OH group by the bulky glycoside present at the C6-O position, forcing the glycosylating agent to react with the comparatively less hindered C2-OH.

### 2.5.7. *myo*-Inositol-Based 4(6),5-Diols

Acylation<sup>28,94a,113</sup> and alkylation<sup>40,67,93f,105d,114</sup> (Scheme 35) of 4,5-diols led to a mixture of products, the C4-O-substituted derivatives (**215**) being major products. Glycosylation<sup>67,114c</sup> of **105** and **106** (Scheme 17) resulted in predominant formation (60–95%) of the corresponding 4-*O*-glycosyl derivatives. The ratio of isomers ( $\alpha$ : $\beta$ ) during glycosylation depended on the promoter used in the reaction.<sup>67a</sup> In contrast, lipase-mediated acetylation of racemic ketal **27** (Scheme 3) in organic solvents resulted in the enantioselective acylation of the C5-OH of the *D*-isomer.<sup>115</sup>

### 2.5.8. *myo*-Inositol-Based 4,6-Diols

There appears to be no published report on the regioselective protection of *myo*-inositol-based 4,6-

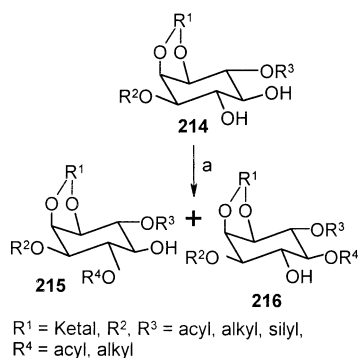
Scheme 35<sup>a</sup>

<sup>a</sup> (a) Acylation or alkylation.

diols in which the other four hydroxyl groups are protected unsymmetrically. The only known 4,6-diols derived from *myo*-inositol are those from *myo*-inositol orthoformate. As these are symmetric, there is no question of regioselectivity in these systems. But one of the hydroxyl groups in these diols (**127**,<sup>35a</sup> **130**<sup>87</sup>) can easily be protected due to strong intramolecular hydrogen bonding between them (section 2.4.5).

## 2.6. Regioselective Regeneration of Hydroxyl Groups from Protected *myo*-Inositols

In previous sections, methods for the selective hydroxyl group protection of **1** and its derivatives were discussed. Another way of obtaining desirably protected *myo*-inositol derivatives is by the selective deprotection of protected hydroxyl groups. Although this approach has not been explored as extensively as the selective protection of *myo*-inositol hydroxyl groups, such deprotection reactions are important, since they provide convenient access to many O-protected *myo*-inositols. In a few cases, these protected *myo*-inositol derivatives cannot be accessed directly by the selective protection of the relevant hydroxyl groups.

### 2.6.1. Selective Cleavage of Ketals

Several reports on the selective cleavage of trans-ketal in the presence of cis-ketal have appeared.<sup>4e,14e,19a,b,40,41,53,93k,95a,b,e,97b,e,99,101,106b,d,107,116</sup> The selective cleavage of trans-ketals is possible due to the lesser stability of the trans-ketals as compared to the cis-ketals. Angyal et al.<sup>19a</sup> prepared **26** (Scheme 3) from a mixture of diketals **27–29** in very good yield by the selective hydrolysis of trans-ketal, since the direct conversion of **1** to **26** seemed to be difficult. A comparison<sup>95e</sup> of the yield and facility of selective deprotection of the trans-isopropylidene group in **217** ( $R^1 = \text{CMe}_2$ , Scheme 36) by transketalization with ethylene glycol showed that the nature of protecting groups  $R^2$  and  $R^3$  influenced the rate of hydrolysis of the 4,5-*trans*-di-*O*-isopropylidene moiety. Hydrolysis of the trans-ketal was slow when ester groups were present and smooth and fast when benzyl groups were present. Generally, the yield of the trans-diol (diketal from triketal or monoketal from diketal) is better when protecting groups are bigger (or more hydrophobic). This could also be due to differences in solubility of the products having different protect-

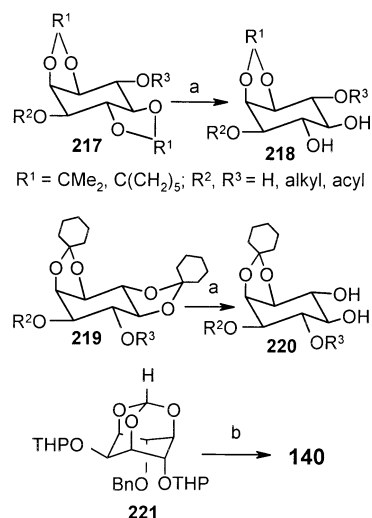
Scheme 36<sup>a</sup>

<sup>a</sup> (a) Acid hydrolysis or solvolysis; (b) aqueous AcOH.

ing groups. However, this aspect has not been investigated systematically in inositol derivatives to separate kinetic and thermodynamic factors that could control such selective cleavage reactions.

Conditions for the selective hydrolytic cleavage of the THP ethers (87%) without affecting the orthoformate moiety in the diTHP ether **221** have been described.<sup>35a</sup> This selective removal of THP ethers, in preference to the orthoformate, could be a consequence of the higher stability of the rigid trioxaadamantane structure of *myo*-inositol orthoformate.

### 2.6.2. Selective Cleavage of Ortho Esters

Ortho esters of **1** have been cleaved by hydrolysis<sup>34a,47,117</sup> or with reducing agents<sup>84,105d,118</sup> to liberate the hydroxyl groups selectively. Partial hydrolysis of ortho esters derived from cis-vicinal diols provided the corresponding axial esters as the major product<sup>119</sup> (Scheme 37). This strategy has been used for the preferential acylation of the C2-OH of cis-1,2-diols derived from **1**.<sup>28d,47,110b,113,117</sup> This is complementary to the normal esterification of cis-1,2-diols (using acylating agents), which results in acylation of the C1-OH group. Acid hydrolysis of **D156** (Scheme 23) is reported<sup>34a</sup> to give a mixture of 3-*O*-acetate **D224** and 1-*O*-acetate **D225**. The 4-deoxy derivative **226**, on treatment with acid in methanol, gave the 2-*O*-pentanoyl derivative **227** (Scheme 37) exclusively.<sup>34b</sup> Formation of the C2-ester **227** in the latter could be due to acyl migration from the C1-O position to the C2-O position. Migration of the acetyl group from the C1-O position to the C2-O position in *myo*-inositol derivatives has been reported earlier.<sup>91b</sup> But this acyl migration is not possible in **D224** and **D225** because the C2-O protecting group is already present. Another route for the formation of **227** could be via the intermediacy of **228**. This route is also not viable in the case of **D156** since the C2-OH is blocked.

Cleavage of *myo*-inositol ortho esters with reducing agents or Grignard reagents affords the corresponding acetal, ketal, or ether in moderate to very good yields (55–98%). The required selectivity in ortho ester cleavage can be achieved by selecting an appropriate reagent (Scheme 38).

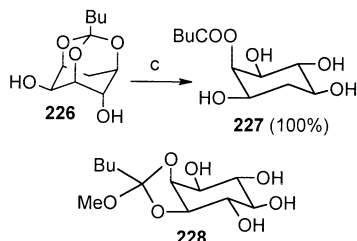
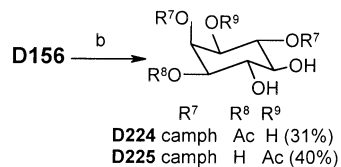
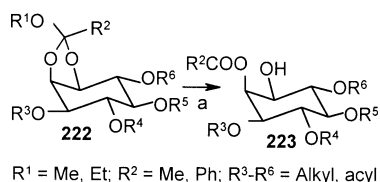

Scheme 37<sup>a</sup>

<sup>a</sup> (a) Acid hydrolysis; (b) 80% aqueous TFA, 7 days; (c) concentrated HCl, MeOH, reflux, 24 h.

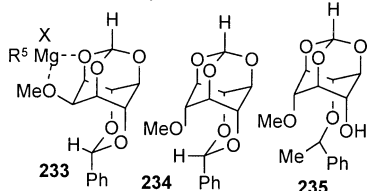
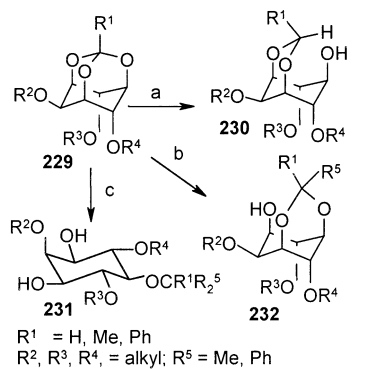
Scheme 38<sup>a</sup>

<sup>a</sup> (a) DIBALH; (b) AlMe<sub>3</sub> or R<sup>5</sup>MgX; (c) R<sup>5</sup>MgX (excess).

Different selectivities observed for the cleavage of *myo*-inositol ortho esters with diisobutylaluminum hydride (DIBALH)<sup>118a,b,e</sup> and trimethylaluminum<sup>84,105d,118b</sup> have been rationalized on the basis of the difference in steric bulk of these reducing agents. The regioselective cleavage of ortho esters effected by Grignard reagents appears to be a result of chelation of magnesium ion with substrates (**233**).<sup>118c</sup> This reasoning is supported by the fact that the *scyllo*-inositol derivative **234**, on treatment with MeMgI, yielded **235** but not the ortho ester-cleaved product(s). From these results, it is clear that cleavage of the ortho ester or the acetal depends on the orientation of the C2 oxygen.

## 2.6.3. Selective Cleavage of Esters

Ester groups have been extensively used in inositol chemistry for the selective protection, ease of isola-

tion,<sup>18c,35c,f,120</sup> and chemical or enzymatic resolution of inositol derivatives. Ester groups have also been used to mask the negative charge of phosphoinositols to increase their ability to cross biological membranes,<sup>28d,90f,121</sup> since esters can be cleaved by intracellular esterases to generate the parent (often hydrophilic) inositol derivative inside the living cell. Also, some *myo*-inositol esters such as surugatoxin, neosurugatoxin, and prosurugatoxin are marine natural products.<sup>122</sup> Esters are frequently used as transient protecting groups for inositol hydroxyl groups. Due to the small differences in the reactivity of different esters in the same molecule, selective non-enzymatic cleavage of one ester over the other is not frequently encountered in the literature. However, there are reports of selective cleavage of esters, many of which were probably discovered by serendipity. One problem associated with the use of esters as protecting groups in polyols is their tendency to migrate (intermolecular or intramolecular) to other hydroxyl groups, leading to loss of selectivity/specificity, during acylation or subsequent manipulations. In inositol-derived esters, acyl migration is almost equally probable in trans and cis directions,<sup>15a,42,63</sup> in basic conditions as mild as traces of pyridine in water.<sup>91</sup> Although acyl migration in polyhydroxy compounds is considered to be a nuisance by a majority of chemists, reports on the exploitation of acyl migration as a key step in the synthesis of *myo*-inositol derivatives have appeared. Since these acyl migrations involve cleavage of one ester (and subsequent formation of another), they are included in the present section.

Acetate and butyrate functions in **D236** (Scheme 39) could be preferentially solvolized in the presence

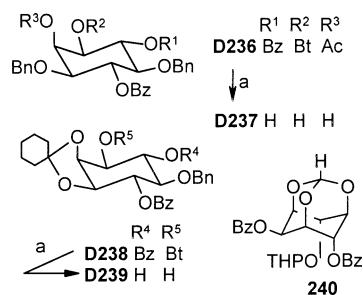
Scheme 39<sup>a</sup>

<sup>a</sup> (a) MeOH, MeONa.

of a base, due to the higher stability of the benzoate groups. However, selective removal of the C6-benzoate (along with acetate and butyrate) without disturbing the C4-benzoate was unexpected.<sup>47</sup> This could be due to the difficulty in the formation of the tetrahedral intermediate at the C4 position as compared to the C6 position due to steric hindrance by the protecting groups at the C3 and C5 positions. This rationale is supported by the fact that the C6-benzoate (along with the butyrate) in **D238** is more labile to methanolysis, as compared to the C4-benzoate.<sup>47</sup> Selective solvolysis of the C4-benzoate over the C2-benzoate in racemic **152** (Scheme 23) was achieved<sup>80</sup> to isolate the 2-benzoate **130** as the major product. That this facile reaction was due to the intramolecular assistance of the neighboring hy-

droxyl group was evident since the C4-benzoate in the THP ether **240** did not undergo solvolysis. Acceleration of ester hydrolysis by a suitably placed neighboring hydroxyl group has been reported earlier.<sup>123</sup>

A comparison of silver(I) oxide–silver halide-mediated alcoholysis of **152**, and its 6-*O*-methyl (**241**) and 6-*O*-sulfonylated derivatives (**244**), under identical conditions revealed interesting results (Scheme 40).<sup>124</sup>

#### Scheme 40<sup>a</sup>

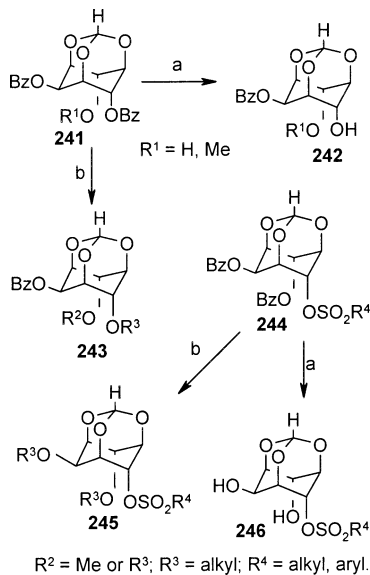

<sup>a</sup> (a) DMF, Ag<sub>2</sub>O, AgX, MeOH; (b) DMF, Ag<sub>2</sub>O, R<sup>3</sup>X.

While only the C4-benzoate underwent solvolysis in the former two (**152**, **241**), to yield the corresponding C2-benzoate **242**, the C4- as well as the C2-benzoates underwent solvolysis in the latter (**244**), to yield racemic 6-*O*-sulfonyl derivatives **246**. The facility of solvolysis of the C4-benzoate in the dibenzoate **152** was much more as compared to that in its methyl ether (**241**, R<sup>1</sup> = Me). These results showed that solvolysis of the C2-benzoate in the sulfonates **244** was a consequence of intramolecular assistance by the sulfonyl group. The catalytic efficiency of the silver halides to bring about solvolysis of the benzoates decreased in the order AgI > AgBr > AgCl. The observed selectivity during solvolysis was attributed to the involvement of silver–inositol derivative chelates. Cleavage of esters and subsequent O-alkylation in *myo*-inositol ortho ester derivatives (**241**, **244**) could be carried out in a one-pot reaction, which provided a new route for the synthesis of important ether derivatives of *myo*-inositol (**243**, **245**), which are intermediates for the preparation of phosphoinositols.<sup>125</sup>

Enzyme-mediated enantioselective hydrolysis of esters in *myo*-inositol derivatives has been used to obtain enantiomeric inositol derivatives. The dibutyrate **247**, on PLE-mediated hydrolysis, gave both regio- and stereoselectively the corresponding butyrate **D248** (Scheme 41).<sup>35a</sup> Cholesterol esterase-mediated hydrolysis<sup>106b</sup> of racemic diacetate **249** yielded (–)-D-1,2:5,6-di-*O*-cyclohexylidene-*myo*-inositol (50%) and L-4-*O*-acetyl-1,2:5,6-di-*O*-cyclohexylidene-*myo*-inositol (38%) in high optical purities. The

#### Scheme 41<sup>a</sup>

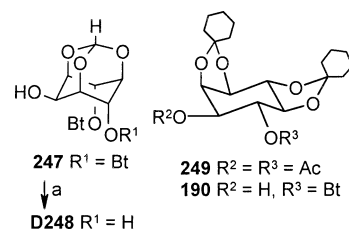

<sup>a</sup> (a) Pig liver esterase.

racemic butyrate **190** has also been resolved<sup>116b</sup> by its enantioselective hydrolysis with PPL. Dinkel et al.<sup>28d</sup> observed a highly regiospecific hydrolysis of a tributryl ester of *myo*-inositol, brought about by lipase from *C. cylindracea*, but with no enantioselectivity.

Base-catalyzed isomerization<sup>126</sup> of the 1,4-dibenzoate **75** (Scheme 13) gave **250** (Chart 3) as the major

#### Chart 3

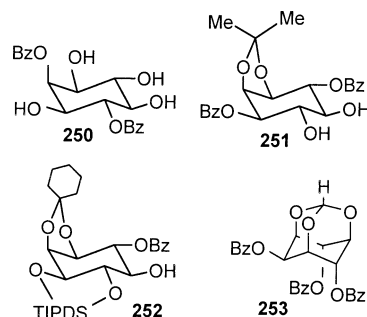

product, which could be phosphorylated to obtain racemic Ins(1,3,4,5)P<sub>4</sub>. This constituted the first report of exploiting ester migration for the synthesis of *myo*-inositol phosphates. Several decades ago, Angyal had encountered<sup>91b</sup> the migration of acetate groups during the tosylation of tetra- and penta-acetates of *myo*-inositol. However, these results were not exploited for the synthesis of biologically important inositol derivatives. Benzoyl group migration in several *myo*-inositol derivatives (e.g., **75**, **251**) was studied by Chung and co-workers.<sup>50,97f,113c,127</sup> They standardized conditions for the separation of isomeric *myo*-inositol polybenzoates by HPLC.<sup>127a</sup> Various benzoates obtained were used for the preparation of *myo*-inositol polyphosphates.<sup>127b</sup> These studies indicated that *cis* migration was generally faster than *trans* migration, and the presence of a cyclic acetal enhanced the *cis/trans* migration ratio. A study of the X-ray crystal structures of **81** (Scheme 13) and **251** indicated that smaller the torsional angle between the vicinal hydroxyl groups, the faster the migration occurred.<sup>128</sup> *Trans*-benzoyl migration has also been observed during the phosphorylation of the TIPDS derivative **252** in the presence of butyllithium.<sup>28a</sup> We reported<sup>75</sup> an unusual 1 → 3 acyl migration in *myo*-inositol orthoformate derivatives. Treatment of 4-*O*-acyl derivatives (**139**, **146**–**150**, Scheme 22) with sodium hydride in DMF resulted in acyl migration to the 2-*O*-position, to provide **129**, **130**, **132**–**135** in very good yields. This, in fact, provided a general and better method for the 2-*O*-acylation of *myo*-inositol ortho esters as compared to their acylation in the

presence of organic bases, wherein the observed regioselectivity was dependent on the acylating agent and the nature of the base, as well as the reaction conditions used (see section 2.4.5). Intermolecular migration of a benzoyl group (in **152**) in the solid state, resulting in the formation of the diol **130** and the tribenzoate **253**, was observed.<sup>129</sup> The facility of this transesterification reaction in the solid state could be explained on the basis of the electrophile–nucleophile interaction between the two molecules of **152** in its crystal.

Selective dephosphorylation<sup>130</sup> of *myo*-inositol hexakisphosphate [Ins(1,2,3,4,5,6)P<sub>6</sub>, phytic acid] with baker's yeast yielded Ins(1,2,6)P<sub>3</sub>, which has anti-inflammatory activity. *myo*-Inositol phosphodiesterases can be obtained by phosphatidylinositol-specific phospholipase C-catalyzed transesterification of *D*-*myo*-inositol 1,2-cyclic phosphate [Ins(1,2-cyc)P] with primary alcohols.<sup>131</sup> However, these methods are unlikely to be useful for the preparation of O-protected *myo*-inositol derivatives, since facile manipulation of the remaining hydroxyl groups is not easy in the presence of phosphates which are prone to migration.

#### 2.6.4. Selective Cleavage of Ethers

Although incidence of selective cleavage among the same types of ethers is less due to their high stability, a few selective ether cleavage reactions in inositol derivatives are reported in the literature. Angyal's report<sup>132</sup> on the regioselective acetolysis of different *myo*-inositol tetra-, penta-, and hexabenzyl ethers with acetic anhydride and 60% perchloric acid (200:1 v/v) constitutes an early report on the selective cleavage of inositol derived ethers. This study revealed that the benzyl ethers at 1-, 2-, and 3-positions are stable, and those at 4-, 5-, and 6-positions are labile to acetolysis. Hexa-*O*-benzyl-*myo*-inositol, however, gave a complex mixture of different mono-, di-, and tribenzyl ethers, and hence the reaction was not synthetically useful. In contrast, Lewis acid (SnCl<sub>4</sub>/TiCl<sub>4</sub>)-assisted cleavage of benzyl ethers in hexa-*O*-benzyl-*myo*-inositol showed some degree of specificity and resulted in the cleavage of the benzyl ethers at the C1 and C2 positions.<sup>19f</sup>

Catalytic hydrogenolysis of **104** (Scheme 42) in the presence of triethylamine resulted in the predominant cleavage of the C3-benzyl ether.<sup>24</sup> Debenzylation

Scheme 42<sup>a</sup>

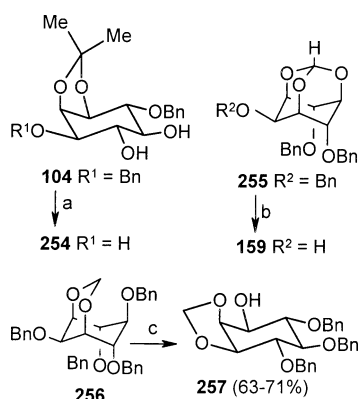

<sup>a</sup> (a) Catalyst, H<sub>2</sub>, NEt<sub>3</sub>; (b) CrCl<sub>2</sub>, LiI; (c) TiCl<sub>4</sub>, CH<sub>2</sub>Cl<sub>2</sub>, –78 °C.

of **255** with CrCl<sub>2</sub>/LiI resulted in the cleavage of the C2-benzyl ether exclusively. This method provides an indirect way of obtaining 4,6-di-*O*-benzyl *myo*-inositol orthoformate, which has so far not been obtained by the direct benzylation of *myo*-inositol orthoformate (see section 2.4.5) in good yields. The observed selective C2-ether cleavage has been attributed to the simultaneous coordination of chromium to oxygens at the C1, C2, and C3 positions.<sup>133</sup> It is of interest to note that 4,6-diaxial dibenzyl ethers in *myo*- and *scyllo*-inositol orthoformates resisted cleavage under the normal hydrogenolysis conditions in the presence of Pd–C, but could be cleaved in the presence of Pd(OH)<sub>2</sub>.<sup>31,87</sup> Gilbert et al.<sup>118a</sup> have reported a selective debenzylation and acetal migration in **256**, leading to the formation of **257** in good yield. Conrad and co-workers<sup>9g</sup> reported a serendipitous observation on the selective oxidative removal of the C6-PMB ether in *D*-1-*O*-allyl-2-*O*-acyl-3,6-di-*O*-(*p*-methoxybenzyl)-4,5-*O*-isopropylidene-*myo*-inositol. However, the cause for this regioselective debenzylation reaction remains a mystery.

### 3. Selective Protection/Deprotection of Inositols Other than the *myo*-Isomer

Reports on the protection/deprotection of hydroxyl groups of inositols other than the *myo*-isomer are few in comparison with the number of reports on the manipulation of the hydroxyl groups in **1**. This is mainly because only a few of them have been isolated from natural sources, and most of the other isomers are synthesized from **1**, carbohydrates, or benzene and its derivatives.<sup>134</sup> Among the known isomeric cyclitols, other than *myo*-inositol, only *chiro*-inositols are relatively abundant in nature, and other isomers are usually synthesized in the laboratory. Consequently, synthetic steps are designed in such a way as to yield the cyclitol derivative with hydroxyl groups protected as desired for future applications. Also, their chemistry is perhaps not well investigated due to a lack of reports on their biological activity. This was indeed the case with **1**, the chemistry of which was resurrected in the past 15 years due to the realization of the biological importance of phosphoinositols. There are reports on the protection/deprotection of hydroxyl groups of both enantiomers of *chiro*-inositol, perhaps because methyl ethers of *chiro*-inositols, **D9** and **L10** (Scheme 1), are available from natural sources and have served as starting materials for the synthesis of several enantiomeric cyclitol derivatives. These naturally occurring methyl ethers were the preferred starting materials for the synthesis of enantiomeric *myo*-inositol derivatives, especially phosphoinositols, before good methods were developed for the resolution/enantioselective reactions of racemic/meso derivatives of **1**.

#### 3.1. *chiro*-Inositols (D2, L2)

The problems concerning selectivity of hydroxyl group protection are less in the case of *chiro*-inositols (as compared to the *myo*-isomer), since they are C<sub>2</sub>-symmetric and hence the selectivity to be achieved during protection of hydroxyl groups is among three

kinds of hydroxyl groups. Furthermore, *chiro*-inositol has two axial hydroxyl groups, which are expected to be less reactive than the four other equatorial hydroxyl groups.

As in the case of **1**, initial protection of hydroxyl groups of *chiro*-inositols is done by ketalization<sup>135</sup> with acetone or cyclohexanone; such reactions invariably result in the formation of a mixture of ketals (Scheme 43). However, ketals of the vicinal hydroxyl

#### Scheme 43<sup>a</sup>

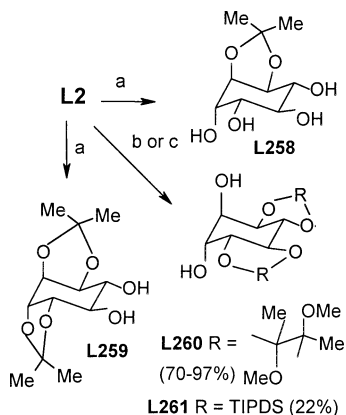

<sup>a</sup> (a) Acetone,  $\text{ZnCl}_2$ ; (b) butanedione,  $\text{CH}(\text{OMe})_2$ , MeOH,  $\text{F}_3\text{B}:\text{OEt}_2$  (or CSA); (c)  $\text{TIPDSCl}_2$ , pyridine.

groups with *cis* geometry are preferentially formed. The experimental procedures have been tuned to obtain either the mono ketal **L258**<sup>135b</sup> or the diketal **L259**<sup>135a</sup> as the major product. Epimerization of hydroxyl groups has been observed during acetalization with chloral.<sup>136</sup> Trans-diequatorial hydroxyl groups can be protected selectively by reaction with 2,3-butanedione and trimethyl orthoformate to obtain **L260**,<sup>137</sup> or with  $\text{TIPDSCl}_2$  to obtain **L261**.<sup>138</sup> Similar hydroxyl group protection reactions are also reported for **D2**.<sup>137,139</sup> Although the reactions of *chiro*-inositols with trans-diol protecting reagents are selective, they often result in a low yield of the protected inositol derivative, and such bulky protecting groups might offer high steric hindrance for further derivatization of the remaining hydroxyl groups, as mentioned earlier (section 2.1).<sup>30</sup>

Benylation of **L2** is reported to yield the tribenzyl ether **L262** (Scheme 44),<sup>140</sup> while benzylation of **D2** in the presence of cesium fluoride yielded dibenzyl and monobenzyl ethers **D264** and **D265** (Scheme 44).<sup>139b,d</sup> In both these reactions, as expected, the axial hydroxyl groups remain unaffected. The difference in product formation observed between the two enantiomers could be due to the differences in the reaction conditions, such as the catalyst, alkyl halide, etc. Silylation of **L2** with  $\text{TBDPSCl}$  gave a low yield of the corresponding monosilyl ether **L263**.<sup>141</sup> Although these benzylation and silylation reactions appear to be selective, the isolated yields of the O-protected inositol derivatives are often low and could involve tedious separation procedures.

Ketalizations of methyl ethers **D9**<sup>142</sup> and **L10**<sup>143</sup> and the mesylate **L267** (Scheme 45), as well as preparation of the ortho ester derivative of **D9**,<sup>144</sup> are reported; monoketals or diketals are obtained in moderate to good yield. But, as observed in the

#### Scheme 44<sup>a</sup>

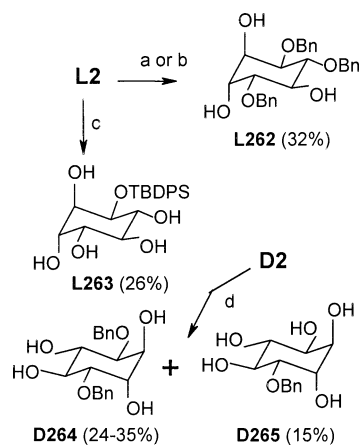

<sup>a</sup> (a)  $\text{Bu}_2\text{SnO}$ ,  $\text{Bu}_4\text{NI}$ ,  $\text{BnCl}$ , MeCN; (b)  $\text{Bu}_2\text{SnO}$ ,  $\text{BnCl}$ ; (c)  $\text{TBDPSCl}$ , DMF; (d)  $\text{Bu}_2\text{SnO}$ ,  $\text{BnBr}$ , CsF, MeCN.

#### Scheme 45<sup>a</sup>

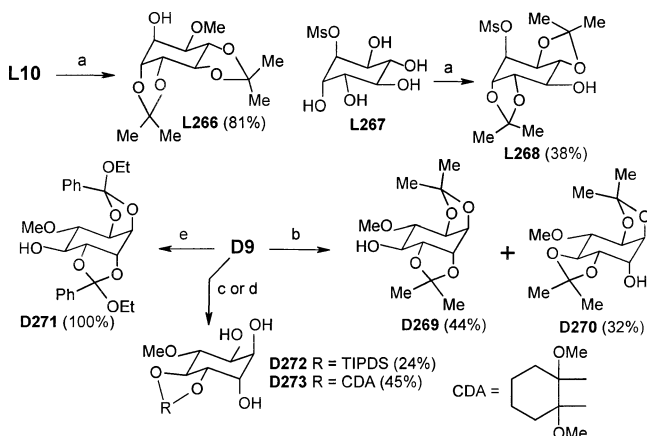

<sup>a</sup> (a) 2-Methoxypropene, CSA; (b) dimethoxypropane, CSA; (c)  $\text{CDA}(\text{OMe})_2$ ,  $\text{HC}(\text{OMe})_3$ , CSA, MeOH; (d)  $\text{TIPDSCl}_2$ , DMAP, imidazole, DMF; (e)  $\text{PhC}(\text{OEt})_3$ ,  $\text{H}^+$ .

reactions of *myo*- and *chiro*-inositols, reagents that result in the protection of vicinal trans-hydroxyl groups give lower yields of the products **D272** and **D273**.<sup>145</sup>

Partial benzylation and benzylation of the dibenzyl ether **D274** (Scheme 46) is reported to yield the tetrabenzyloxy ether **D275**<sup>137a</sup> and the tribenzoate **D276**,<sup>146</sup> respectively. As expected, the equatorial hydroxyl groups get protected preferentially. However, whether the formation of the tribenzoate **D276** is a result of benzoyl group migration among the hydroxyl groups has not been investigated. This question arises, especially since 60% of the material is unaccounted for.

#### Scheme 46<sup>a</sup>

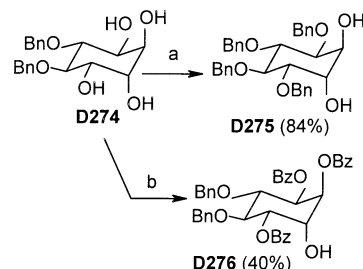

<sup>a</sup> (a)  $\text{Bu}_2\text{SnO}$ ,  $\text{BnBr}$ ; (b)  $\text{BzCl}$ , pyridine.

Ketalizations of the triols **D272** and **D273** (Scheme 47) yield the corresponding ketals, **D277** and **D278**,<sup>145</sup> in which the axial hydroxyl group is free.

#### Scheme 47<sup>a</sup>

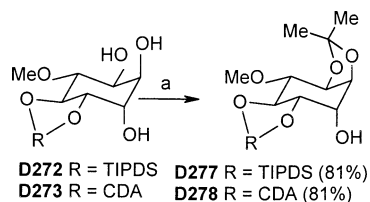

<sup>a</sup> (a) 2,2-Dimethoxypropane, TsOH, acetone.

Acylation or alkylation of the tetra-O-protected *chiro*-inositol derivatives (Scheme 48), in which the

#### Scheme 48<sup>a</sup>

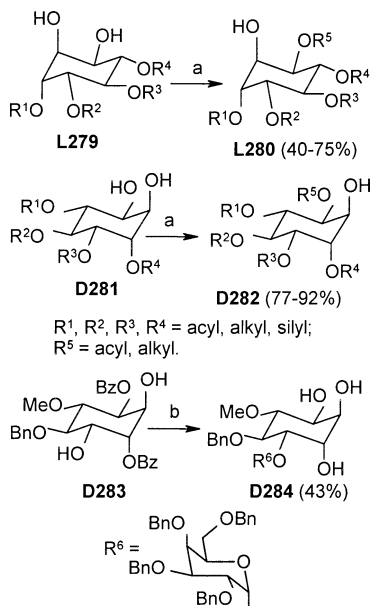

<sup>a</sup> (a) Acylation or alkylation; (b) (i) R<sup>6</sup>OC(=NMe)Me, NEt<sub>3</sub>; (ii) NaOMe.

two hydroxyl groups have relative axial–equatorial orientation, results in predominant protection of the equatorial hydroxyl group, irrespective of the protecting groups used for the protection of the other four hydroxyl groups.<sup>6a,135,139a,140a,142,144,147</sup> This perhaps indicates that conformation of the carbocyclic ring does not deviate from the chair form, even after heavy substitution, as observed in *myo*-inositol derivatives. Monobenzylation of the C<sub>2</sub>-symmetric diol **L259** (Scheme 43), which has vicinal equatorial hydroxyl groups, results in the formation of the only possible monoether.<sup>148</sup> However, considerable efforts were required to obtain monoesters of **L259** and its enantiomer.<sup>149</sup>

Scheme 49 shows selective deprotection reactions of some *chiro*-inositol derivatives. Triketals **L285** and **L286** were used to prepare diketals **L259** and **L287** by selective cleavage of the trans-ketal,<sup>4d,148,150</sup> since the yield of these diketals by the direct ketalization of **L2** was low. The yield of the diketal obtained was better for the cleavage of the cyclohexylidene derivative **L286** as compared to the isopropylidene derivative **L285**. Similarly, in the diketal **L288**, the trans-

#### Scheme 49<sup>a</sup>

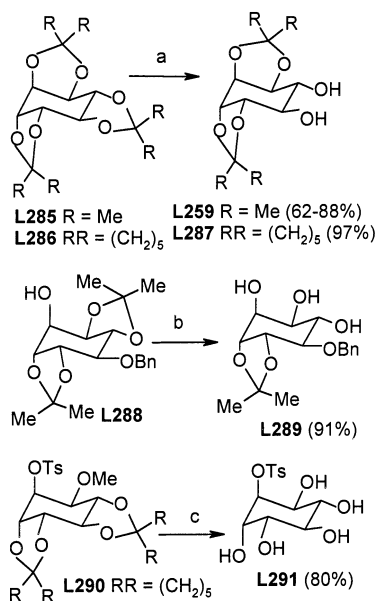

<sup>a</sup> (a) H<sup>+</sup>, MeOH; (b) AcCl (catalytic), MeOH–CH<sub>2</sub>Cl<sub>2</sub>; (c) BCl<sub>3</sub>, –60 °C.

ketal could be cleaved selectively to obtain the monoketal **L289**.<sup>142</sup> This approach (selective cleavage of triketals to obtain diketals) has not been used for the preparation of diketals of **1**. It is likely that **1**, on ketalization, results in the formation of oligomers due to the presence of five equatorial hydroxyl groups instead of forming the triketal in high yields. In the case of *chiro*-inositols, formation of oligomers is perhaps prevented due to the presence of two axial hydroxyl groups, which results in the formation of two relatively stable cis-ketals. Deprotection of the methyl ether **L290** presents an interesting case wherein boron trichloride is used to cleave the ketals as well as the methyl ether, leaving the tosylate undisturbed.<sup>151</sup>

The differences in reactivity between esters of aliphatic and aromatic carboxylic acids have been exploited to solvolyze the acetate **L292** in the presence of a benzoate (Scheme 50).<sup>152</sup> The modest success of this selective deprotection is perhaps due to the fact that vicinal hydroxyl groups to the benzoate in **L292** are blocked as ethers. Free hydroxyl groups at these positions could have resulted in the migration of the benzoyl group. Benzoyl migration in *chiro*-

#### Scheme 50<sup>a</sup>

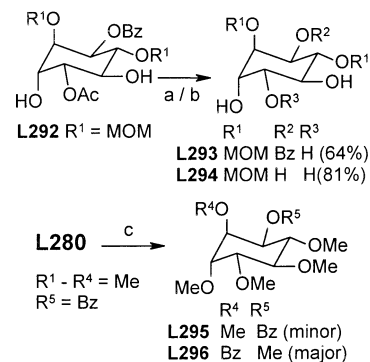

<sup>a</sup> (a) MeOH–MeONa (0.1 equiv); (b) MeOH–MeONa (10 equiv); (c) MeI/Ag<sub>2</sub>O.

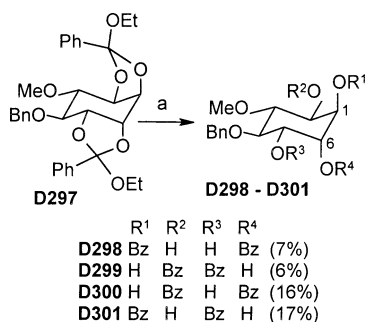
Scheme 51<sup>a</sup>

<sup>a</sup> (a) 80% aqueous AcOH.

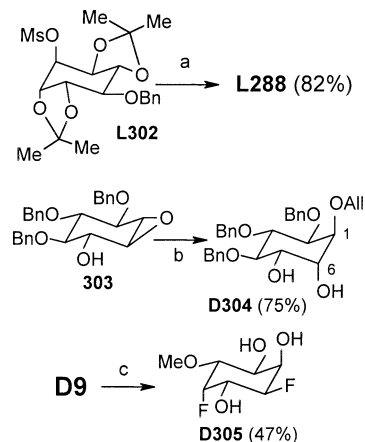
Scheme 52<sup>a</sup>

<sup>a</sup> (a) LiAlH<sub>4</sub>, THF; (b) F<sub>3</sub>B·OEt<sub>2</sub>, AlOH; (c) DAST.

inositol derivatives has been observed during the methylation of the benzoate **L280** (R<sup>1</sup> = R<sup>2</sup> = R<sup>3</sup> = R<sup>4</sup> = Me, R<sup>5</sup> = Bz) in the presence of silver(I) oxide.<sup>153</sup> It is also interesting to see that much less than 1 equiv of sodium methoxide (0.1 equiv) brings about 64% cleavage of the acetate. Whether the remaining 36% of the material consists of a mixture of **L292** and its isomeric acetates is not clear. It is known that the acetyl group migrates among the hydroxyl groups of inositol with extreme facility.<sup>63,90b</sup>

*chiro*-Inositol hydroxyl groups have also been protected as ortho esters (Scheme 51), which on partial hydrolysis yield the corresponding esters.<sup>144</sup> Whether the lack of specificity observed (see section 2.6.2) is due to a lack of specificity during cleavage of the ortho esters or due to migration of the resulting acyl groups has not been investigated.

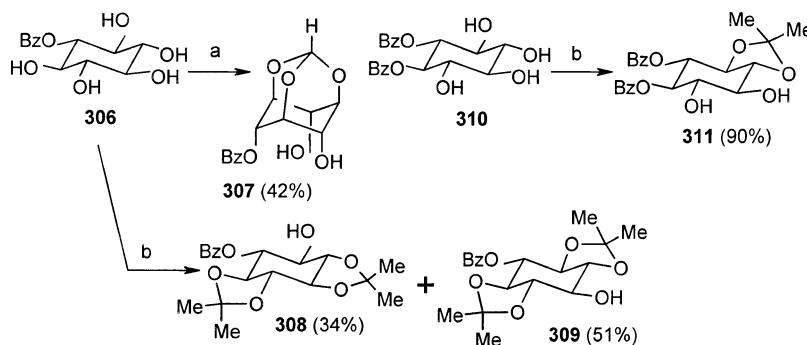
Scheme 53<sup>a</sup>

<sup>a</sup> (a) HC(OMe)<sub>3</sub>/H<sup>+</sup>; (b) 2-methoxypropene/H<sup>+</sup>.

Other selective reactions of *chiro*-inositol derivatives (Scheme 52) include selective deprotection of the mesylate **L302** in the presence of ketals,<sup>142</sup> BF<sub>3</sub>-catalyzed regioselective opening of the epoxide **303** with allyl alcohol,<sup>139a</sup> and fluorination of **D9** with (diethylamino)sulfur trifluoride (DAST).<sup>143</sup>

3.2. *scyllo*-Inositol (3)

*scyllo*-Inositol is the simplest among the isomers of inositol in terms of symmetry, since all the hydroxyl groups are equatorial. Its solubility in solvents is low, perhaps because of the high lattice energy that results from the strong hydrogen bonds that are possible due to its symmetry. The question of selective monoprotection of hydroxyl groups of **3** does not arise, since all the hydroxyl groups are equivalent.

Ketalization of the monobenzoate **306** (Scheme 53) results in a mixture of diketals **308** and **309**, while protection with triethyl orthoformate leads to the diol **307**, the only possible product, in low yield.<sup>154</sup> It is interesting to note that the reaction of **3** with triethyl orthoformate does not lead to the formation of its ortho ester.<sup>155</sup> Ketalization of the dibenzoate **310** leads almost exclusively to the monoketal **311**,<sup>154</sup> but the reason for this high selectivity does not seem to be clear.

Intramolecular migration of acyl groups has been exploited<sup>154</sup> to prepare isomeric *O*-acylated *scyllo*-inositol derivatives, which serve as precursors for the synthesis of *scyllo*-inositol phosphates. Treatment of benzoates **310** and **316** (Scheme 54) with aqueous pyridine gave rise to a mixture of isomeric benzoates, which were separated by HPLC, and the individual isomers were phosphorylated to obtain *scyllo*-inositol phosphates. The dibenzoate **310** was also used to prepare isomeric tribenzoates **312** and **313**, which were used as precursors for *scyllo*-inositol trisphosphates. It is likely that the reactivities of the two sets of hydroxyl groups (due to the presence of a plane of symmetry in **310**) are the same. Again, it is not clear whether the observed product formation on benzylation of **310** is due to migration of the benzoyl groups subsequent to benzylation (selectively at one of the hydroxyl groups of **310**).

3.3. *epi*-Inositol (4)

Ketals of **4** have been prepared directly from **4** as well as by the selective cleavage of its triketal **320**

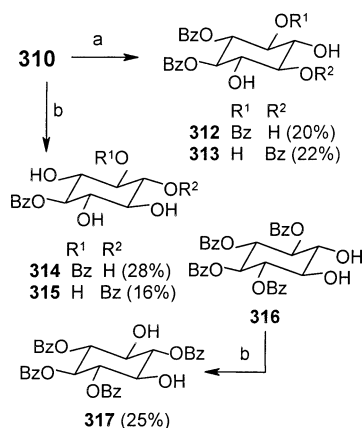
Scheme 54<sup>a</sup>

<sup>a</sup> (a) BzCl/pyridine; (b) aqueous pyridine.

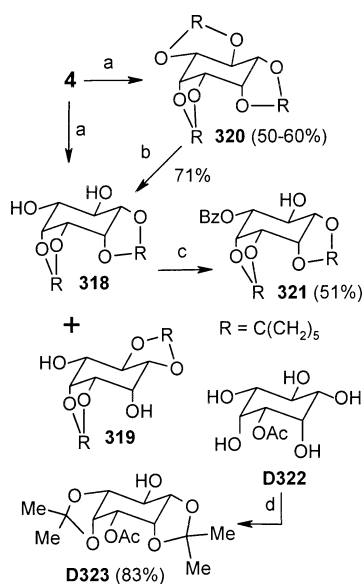
Scheme 55<sup>a</sup>

<sup>a</sup> (a) Cyclohexanone/H<sup>+</sup>; (b) water/H<sup>+</sup>; (c) BzCl/pyridine; (d) acetone/H<sup>+</sup>, 0 °C.

(Scheme 55). In the former experiment, one of the diketals (**319**) could be separated by crystallization.<sup>156</sup> During the partial hydrolysis of **320** to obtain the diketal **318**, a solvent mixture (benzene–light petroleum) in which it has very low solubility had to be used, as **318** is susceptible to further hydrolysis. Coupled with nucleation, this procedure resulted in crystallization of the diketal **318** from the reaction mixture in about 70% yield. Ketalization of the acetate **D322** resulted in the protection of vicinal cis-hydroxyl groups.<sup>134</sup> Benzoylation of the diol **318** gave the monobenzoate **321** as the major product;<sup>156</sup> similar results were observed during tosylation of **318**. The preferential acylation observed was thought to be due to the intramolecular hydrogen bonding of the reactive hydroxyl group with the vicinal cis oxygen.<sup>19a</sup>

3.4. *cis*-Inositol (5)

*cis*-Inositol is an interesting compound, first isolated from a mixture of products obtained on high-pressure hydrogenation of tetrahydroxyquinone.<sup>157a</sup> It readily forms strong complexes with metal ions and

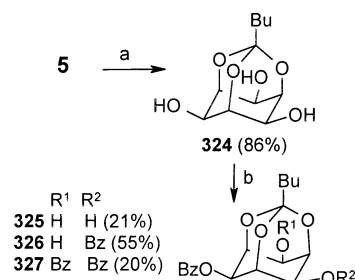
Scheme 56<sup>a</sup>

<sup>a</sup> (a) BuC(OMe)<sub>3</sub>/H<sup>+</sup>; (b) BzCl, pyridine.

oxyacid anions (such as borate) due to the presence of three syn-axial hydroxyl groups.<sup>157b</sup> Ortho ester **324** (Scheme 56) was obtained in very good yield from *cis*-inositol which has three axial and three equatorial hydroxyl groups. Benzoylation of **324** gave a mixture of mono-, di-, and tribenzoates.<sup>74</sup>

3.5. *muco*-Inositol (6)

The dibenzyl ether **328** (Scheme 57) of *muco*-inositol, on benzoylation, resulted in the formation of the dibenzoate **329** as expected, leaving the axial hydroxyl groups undisturbed.<sup>158</sup>

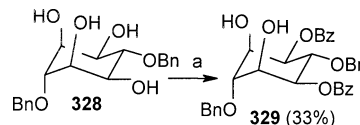
Scheme 57<sup>a</sup>

<sup>a</sup> (a) Benzoyl imidazole.

## 4. Conclusions

The chemistry of inositols developed in the past two decades has reached a level of understanding that seems to allow a prediction of the regioselectivity and relative reactivity of hydroxyl groups of many inositol derivatives. By choosing an appropriate method, any desirably protected *myo*-inositol derivative can be synthesized. Although enzymatic methods of resolution of *myo*-inositol derivatives have contributed much to the total synthesis of inositol phosphates and related lipids, further investigation is necessary to understand and explain the regioselectivities and enantioselectivities observed. A valuable alternative to chemical or enzyme-mediated resolution of inositol derivatives is the direct chromatography of enantiomers, but this technique has not yet been explored sufficiently.<sup>28d,110b,159</sup>

The general trend of reactivity among hydroxyl groups observed in *myo*-inositol (or its derivatives) is C-1 (C-3) > C-4 (C-6) > C-5 > C-2, except in *myo*-inositol 1,3,5-ortho esters, where the reactivity pattern is C-4 > C-2 ~ C-6. Although a general pattern of selectivity is observed in the reactivity of *myo*-inositol hydroxyl groups, the selectivity could be altered in some derivatives by manipulating the protecting groups. Differences in reactivity between axial and equatorial hydroxyl groups are reasonably well understood in terms of conformation and steric hindrance, but there are several exceptions to this. The nonequivalence of the reactivity of equatorial hydroxyl groups requires further study. Such general

statements on the relative reactivity of hydroxyl groups of other isomers of inositols cannot be made since they have not been investigated extensively. However, it is clear that relative reactivities of the inositol hydroxyl groups are often dependent on factors such as intramolecular and intermolecular interactions, especially hydrogen bonding and metal ion chelation effects, which are influenced by reaction conditions and other reagents/solvents present in the reaction mixture. Furthermore, a chemical modification at a given position on the inositol ring could induce changes in other functional groups in the ring due to charge distributions, hydrogen bonding, conformational change, chelation, steric bulk, etc., which could result in a change of the relative reactivities of the hydroxyl groups. The X-ray crystal structures of inositol derivatives could provide important data for explaining or predicting the reactivity of hydroxyl groups. However, this approach needs to be pursued more vigorously in research related to inositols. Investigations on the chemistry of inositols have also had implications in areas of chemistry such as natural product synthesis,<sup>5k,160</sup> asymmetric synthesis,<sup>161</sup> reaction mechanisms,<sup>129</sup> development of novel metal complexing agents,<sup>32,162</sup> supramolecular chemistry,<sup>163</sup> liquid crystals,<sup>108,164</sup> and polymers.<sup>165</sup> Hence, it appears that the potential of using inositol derivatives in different areas of chemistry is ever-expanding and could open up newer areas of research and applications.

## 5. Acknowledgment

The Department of Science and Technology, New Delhi, supported most of the work related to inositols carried out in our laboratory. K.M.S. and T.P. are recipients of research fellowships from the Council of Scientific and Industrial Research, New Delhi. T.D. is a recipient of a research fellowship from the University Grants Commission, New Delhi. We appreciate Mr. S. Devaraj's efforts in the preparation of this manuscript. We also acknowledge the input from and discussions with Dr. Mohan Bhadbhade and Rajesh Gonnade while preparing this article for publication.

## 6. References

- (1) (a) Thomas, J. R.; Dwek, R. A.; Rademacher, T. W. *Biochemistry* **1990**, *29*, 5413. (b) Potter, B. V. L.; Lampe, D. *Angew. Chem., Int. Ed. Engl.* **1995**, *34*, 1933. (c) Hinchliffe, K.; Irvine, R. *Nature* **1997**, *390*, 123. (d) *The Inositol Phosphates. Chemical Synthesis and Biological Significance*; Billington, D. C., Ed.; VCH: New York, 1993. (e) *Phosphoinositides: Chemistry, Biochemistry and Biomedical Applications*; Bruzik, K. S., Ed.; ACS Symposium Series 718; American Chemical Society: Washington, DC, 1999.
- (2) Liang, C.; Ewig, C. S.; Stouch, T. R.; Hagler, A. T. *J. Am. Chem. Soc.* **1994**, *116*, 3904.
- (3) Ozaki, S.; Lei, L. Chemoenzymatic Synthesis of Optically active myo-inositol polyphosphate. In *Carbohydrates in Drug Design*; Witzcak Z. J., Nieforth, K. A., Eds.; Marcel Dekker: New York, 1997; p 343.
- (4) (a) Kozikowski, A. P.; Powis, G.; Gallegos, A.; Tückmantel, W. *Bioorg. Med. Chem. Lett.* **1993**, *3*, 1323. (b) Kozikowski, A. P.; Fauq, A. H.; Malaska, W.; Tückmantel, W.; Ioguyanov, V.; Powis, G. *Curr. Med. Chem.* **1994**, *1*, 1. (c) Kiddle, J. J. *Chem. Rev.* **1995**, *95*, 2189. (d) Chida, N.; Sakata, N.; Murai, K.; Tobe, T.; Nagase, T.; Ogawa, S. *Bull. Chem. Soc. Jpn.* **1998**, *71*, 259. (e) Qiao, L.; Hu, Y.; Nan, F.; Powis, G.; Kozikowski, A. P. *Org. Lett.* **2000**, *2*, 115.
- (5) (a) Bender, S. L.; Budhu, R. J. *J. Am. Chem. Soc.* **1991**, *113*, 9883. (b) Safrany, S. T.; Wojcikiewicz, R. J. H.; Strupish, J.; Nahorski, S. R.; Dubreuil, D.; Cleophax, J.; Géro, S. D.; Potter, B. V. L. *FEBS Lett.* **1991**, *278*, 252. (c) Estevez, V. A.; Prestwich, G. D. *J. Am. Chem. Soc.* **1991**, *113*, 9885. (d) Sato, K.; Bokura, M.; Taniguchi, M. *Bull. Chem. Soc. Jpn.* **1994**, *67*, 1633. (e) Prestwich, G. D. *Acc. Chem. Res.* **1996**, *29*, 503. (f) Dubreuil, D.; Cleophax, J.; de Almeida, M. V.; Verre-Sebrié, C.; Liaigre, J.; Vass, G.; Géro, S. D. *Tetrahedron* **1997**, *53*, 16747. (g) Chen, J.; Feng, L.; Prestwich, G. D. *J. Org. Chem.* **1998**, *63*, 6511. (h) Kornienko, A.; Turner, D. I.; Jaworek, C. H.; d'Alarcao, M. *Tetrahedron: Asymmetry* **1998**, *9*, 2783. (i) Clive, D. L. J.; He, X.; Postema, M. H. D.; Mashimbye, M. J. *J. Org. Chem.* **1999**, *64*, 4397. (j) Nishikawa, A.; Saito, S.; Hashimoto, Y.; Koga, K.; Shirai, R. *Tetrahedron Lett.* **2001**, *42*, 9195. (k) Suzuki, T.; Suzuki, S. T.; Yamada, I.; Koashi, Y.; Yamada, K.; Chida, N. *J. Org. Chem.* **2002**, *67*, 2874.
- (6) (a) Kornienko, A.; d'Alarcao, M. *Tetrahedron Lett.* **1997**, *38*, 6497. (b) Jenkins, D. J.; Potter, B. V. L. *J. Chem. Soc., Perkin Trans. 1* **1998**, 41.
- (7) Chiara, J. L.; Martín-Lomas, M. *Tetrahedron Lett.* **1994**, *35*, 2969.
- (8) Guidot, J. P.; Le Gall, T.; Mioskowski, C. *Tetrahedron Lett.* **1994**, *35*, 6671.
- (9) (a) Falck, J. R.; Abdali, A. In *Inositol Phosphates and Derivatives. Synthesis, Biochemistry, and Therapeutic Potential*; Reitz, A. B., Ed.; ACS Symposium Series 463; American Chemical Society: Washington, DC, 1991; p 145. (b) Reddy, K. K.; Saady, M.; Falck, J. R. *J. Org. Chem.* **1995**, *60*, 3385. (c) Sawada, T.; Shirai, R.; Iwasaki, S. *Tetrahedron Lett.* **1996**, *37*, 885. (d) Reddy, K. K.; Rizo, J.; Falck, J. R. *Tetrahedron Lett.* **1997**, *38*, 4729. (e) Reddy, K. K.; Ye, J.; Falck, J. R.; Capdevila, J. H. *Bioorg. Med. Chem. Lett.* **1997**, *7*, 2115. (f) Colobert, F.; Tito, A.; Khiar, N.; Denni, D.; Medina, M. A.; Martín-Lomas, M.; Ruano, J.-L. G.; Solladié, G. *J. Org. Chem.* **1998**, *63*, 8918. (g) Conrad, R. M.; Grogan, M. J.; Bertozzi, C. R. *Org. Lett.* **2002**, *4*, 1359.
- (10) (a) Ley, S. V.; Parra, M.; Redgrave, A. J.; Sternfeld, F. *Tetrahedron* **1990**, *46*, 4995. (b) Hudlicky, T. *Chem. Rev.* **1996**, *96*, 3. (c) Nguyen, B. V.; York, C.; Hudlicky, T. *Tetrahedron* **1997**, *53*, 8807 and references therein. (d) Paul, B. J.; Willis, J.; Martinot, T. A.; Ghiviriga, I.; Abboud, K. A.; Hudlicky, T. *J. Am. Chem. Soc.* **2002**, *124*, 10416. (e) Mehta, G.; Senaiar, R. S.; Bera, M. K. *Chem.-Eur. J.* **2003**, *9*, 2264.
- (11) Kim, K. S.; Park, J. I.; Moon, H. K.; Yi, H. *Chem. Commun.* **1998**, 1945.
- (12) (a) Plettenburg, O.; Adelt, S.; Vogel, G.; Altenbach, H.-J. *Tetrahedron: Asymmetry* **2000**, *11*, 1057. (b) Adelt, S.; Plettenburg, O.; Dallmann, G.; Ritter, F. P.; Shears, S. B.; Altenbach, H.-J.; Vogel, G. *Bioorg. Med. Chem. Lett.* **2001**, *11*, 2705. (c) Podeschwa, M.; Plettenburg, O.; vom Brocke, J.; Block, O.; Adelt, S.; Altenbach, H.-J. *Eur. J. Org. Chem.* **2003**, 1958.
- (13) Collins, P.; Ferrier, R. *Monosaccharides. Their chemistry and their roles in natural products*; John Wiley & Sons Ltd.: West Sussex, England, 1995; p 449.
- (14) For example, see: (a) Bruzik, K. S.; Myers, J.; Tsai, M.-D. *Tetrahedron Lett.* **1992**, *33*, 1009. (b) Martin, S. F.; Josey, J. A.; Wong, Y.-L.; Dean, D. W. *J. Org. Chem.* **1994**, *59*, 4805. (c) Rudolf, M. T.; Schultz, C. *Liebigs Ann.* **1996**, 533 and references therein. (d) Mayer, T. G.; Schmidt, R. R. *Liebigs Ann./Recueil* **1997**, 859. (e) Suzuki, T.; Tanaka, S.; Yamada, I.; Koashi, Y.; Yamada, K.; Chida, N. *Org. Lett.* **2000**, *2*, 1137. (f) Riley, A. M.; Correa, V.; Mahon, M. F.; Taylor, C. W.; Potter, B. V. L. *J. Med. Chem.* **2001**, *44*, 2108. (g) Sureshan, K. M.; Yamasaki, T.; Hayashi, M.; Watanabe, Y. *Tetrahedron: Asymmetry* **2003**, *14*, 1771.
- (15) (a) Shvets, V. I. *Russ. Chem. Rev.* **1974**, *43*, 488. (b) Cosgrove, D. J. *Inositol phosphates: Their chemistry, biochemistry and physiology*; Elsevier: New York, 1980.
- (16) Parthasarathy, R.; Eisenberg, F., Jr. *Biochem. J.* **1986**, *235*, 313.
- (17) Nomenclature committee, IUB. *Biochem. J.* **1989**, *258*, 1.
- (18) (a) Angyal, S. J.; MacDonald, C. G. *J. Chem. Soc.* **1952**, 686. (b) Gigg, R.; Warren, C. D. *J. Chem. Soc. (C)* **1969**, 2367. (c) Gigg, J.; Gigg, R.; Payne, S.; Conant, R. *Carbohydr. Res.* **1985**, *142*, 132. (d) Hudlicky, T.; Entwistle, D. A.; Pitzer, K. K.; Thorpe, A. *J. Chem. Rev.* **1996**, *96*, 1195.
- (19) (a) Angyal, S. J.; Tate, M. E.; Géro, S. D. *J. Chem. Soc.* **1961**, 4116. (b) Angyal, S. J.; Irving, G. C.; Rutherford, D.; Tate, M. E. *J. Chem. Soc.* **1965**, 6662. (c) Garegg, P. J.; Iversen, T.; Johansson, R.; Lindberg, B. *Carbohydr. Res.* **1984**, *130*, 322. (d) Vacca, J. P.; deSolms, S. J.; Huff, J. R.; Billington, D. C.; Baker, R.; Kulagowski, J. J.; Mawer, I. M. *Tetrahedron* **1989**, *45*, 5679. (e) Baker, G. R.; Billington, D. C.; Gani, D. *Tetrahedron* **1991**, *47*, 3895. (f) Koto, S.; Hirooka, M.; Yoshida, T.; Takenaka, K.; Asai, C.; Nagamitsu, T.; Sakuma, H.; Sakurai, M.; Masuzawa, S.; Komiyama, M.; Sato, T.; Zen, S.; Yago, K.; Tomonaga, F. *Bull. Chem. Soc. Jpn.* **2000**, *73*, 2521.
- (20) Reese, C. B.; Ward, J. G. *Tetrahedron Lett.* **1987**, *28*, 2309.
- (21) Angyal, S. J.; Hoskinson, R. M. *J. Chem. Soc.* **1963**, 2043.



- (22) Desai, T.; Gigg, J.; Gigg, R.; Payne, S.; Penades, S.; Rogers, H. *J. Carbohydr. Res.* **1992**, *216*, 197.
- (23) (a) Haines, A. H. *Adv. Carbohydr. Chem. Biochem.* **1976**, *33*, 11. (b) Knapp, S.; Kukkola, P. J.; Sharma, S.; Dhar, T. G. M.; Naughton, A. B. *J. Org. Chem.* **1990**, *55*, 5700.
- (24) Desai, T.; Gigg, J.; Gigg, R.; Martín-Zamora, E.; Schnetz, N. *Carbohydr. Res.* **1994**, *258*, 135.
- (25) (a) Bruzik, K. S.; Salamończyk, G. M. *Carbohydr. Res.* **1989**, *195*, 67. (b) Bruzik, K. S.; Tsai, M.-D. *J. Am. Chem. Soc.* **1992**, *114*, 6361. (c) Lindberg, J.; Ohberg, L.; Garegg, P. J.; Konradsson, P. *Tetrahedron* **2002**, *58*, 1387. (d) Kubiak, R. J.; Bruzik, K. S. *J. Org. Chem.* **2003**, *68*, 960.
- (26) Salamończyk, G. M.; Pietrusiewicz, M. *Tetrahedron Lett.* **1991**, *32*, 4031.
- (27) Downham, R.; Edwards, P. J.; Entwistle, D. A.; Hughes, A. B.; Kim, K. S.; Ley, S. V. *Tetrahedron: Asymmetry* **1995**, *6*, 2403.
- (28) (a) Watanabe, Y.; Mitani, M.; Morita, T.; Ozaki, S. *J. Chem. Soc., Chem. Commun.* **1989**, 482. (b) Montchamp, J.-L.; Tian, F.; Hart, M. E.; Frost, J. W. *J. Org. Chem.* **1996**, *61*, 3897. (c) Riley, A. M.; Jenkins, D. J.; Potter, B. V. L. *Carbohydr. Res.* **1998**, *314*, 277. (d) Dinkel, C.; Moody, M.; Traynor-Kaplan, A.; Schultz, C. *Angew. Chem., Int. Ed.* **2001**, *40*, 3004.
- (29) Markiewicz, W. T.; Padyukova, N. S.; Samek, S.; Smrt, J. *Collect. Czech. Chem. Commun.* **1980**, *45*, 1860.
- (30) Martín-Lomas, M.; Khair, N.; Garcia, S.; Koessler, J.-L.; Nieto, P. M.; Rademacher, T. W. *Chem.-Eur. J.* **2000**, *6*, 3608.
- (31) Lee, H. W.; Kishi, Y. *J. Org. Chem.* **1985**, *50*, 4402.
- (32) Tse, B.; Kishi, Y. *J. Am. Chem. Soc.* **1993**, *115*, 7892.
- (33) Luk'yanov, A. V.; Tolkachev, O. N. USSR Patent 184841, 1966; *Chem. Abstr.* **1967**, *66*, 95365x.
- (34) (a) Garrett, S. W.; Liu, C.; Riley, A. M.; Potter, B. V. L. *J. Chem. Soc., Perkin Trans. 1* **1998**, 1367. (b) Biamonte, M. A.; Vasella, A. *Helv. Chim. Acta* **1998**, *81*, 688.
- (35) (a) Baudin, G.; Glänzer, B. I.; Swaminathan, K. S.; Vasella, A. *Helv. Chim. Acta* **1988**, *71*, 1367. (b) Billington, D. C.; Baker, R.; Kulagowski, J. J.; Mawer, I. M.; Vacca, J. P.; deSolms, S. J.; Huff, J. R. *J. Chem. Soc., Perkin Trans. 1* **1989**, 1423. (c) Andersch, P.; Schneider, M. P. *Tetrahedron: Asymmetry* **1993**, *4*, 2135. (d) Ozaki, S.; Koga, Y.; Ling, L.; Watanabe, Y.; Kimura, Y.; Hirata, M. *Bull. Chem. Soc. Jpn.* **1994**, *67*, 1058. (e) Zhu, W.; Li, Z. *Synth. Commun.* **2000**, *30*, 3823. (f) Praveen, T.; Shashidhar, M. S. *Carbohydr. Res.* **2001**, *330*, 409.
- (36) Zapata, A.; Bernet, B.; Vasella, A. *Helv. Chim. Acta* **1996**, *79*, 1169.
- (37) Watanabe, Y.; Shinohara, T.; Fujimoto, T.; Ozaki, S. *Chem. Pharm. Bull.* **1990**, *38*, 562.
- (38) Gaffney, P. R. J.; Reese, C. B. *J. Chem. Soc., Perkin Trans. 1* **2001**, 192.
- (39) (a) Aguiló, A.; Martín-Lomas, M.; Penadés, S. *Tetrahedron Lett.* **1992**, *33*, 401. (b) Martín-Lomas, M.; Flores-Mosquera, M.; Chiara, J. L. *Eur. J. Org. Chem.* **2000**, 1547.
- (40) Fauq, A. H.; Zaidi, J. H.; Wilcox, R. A.; Varvel, G.; Nahorski, S. R.; Kozikowski, A. P.; Erneux, C. *Tetrahedron Lett.* **1996**, *37*, 1917.
- (41) Kozikowski, A. P.; Fauq, A. H.; Aksoy, I. A.; Seewald, M. J.; Powis, G. *J. Am. Chem. Soc.* **1990**, *112*, 7403.
- (42) Angyal, S. J.; Hoskinson, R. M. *J. Chem. Soc.* **1962**, 2985.
- (43) Seewald, M. J.; Aksoy, I. A.; Powis, G.; Fauq, A. H.; Kozikowski, A. P. *J. Chem. Soc., Chem. Commun.* **1990**, 1638.
- (44) Kozikowski, A. P.; Fauq, A. H.; Powis, G.; Kurian, P.; Crews, F. T. *J. Chem. Soc., Chem. Commun.* **1992**, 362.
- (45) Bruzik, K. S.; Kubiak, R. J. *Tetrahedron Lett.* **1995**, *36*, 2415.
- (46) Laumen, K.; Ghisalpa, O. *Biosci., Biotechnol., Biochem.* **1994**, *58*, 2046.
- (47) Andersch, P.; Schneider, M. P. *Tetrahedron: Asymmetry* **1996**, *7*, 349.
- (48) (a) Gigg, J.; Gigg, R.; Payne, S.; Conant, R. *J. Chem. Soc., Perkin Trans. 1* **1987**, 1757. (b) Desai, T.; Gigg, J.; Gigg, R.; Payne, S.; Penades, S. *Carbohydr. Res.* **1992**, *234*, 1. (c) Liu, C.; Potter, B. V. L. *Tetrahedron Lett.* **1994**, *35*, 8457. (d) Liu, C.; Potter, B. V. L. *Tetrahedron Lett.* **1994**, *35*, 1605. (e) Riley, A. M.; Payne, R.; Potter, B. V. L. *J. Med. Chem.* **1994**, *37*, 3918. (f) Liu, C.; Potter, B. V. L. *J. Org. Chem.* **1997**, *62*, 8335.
- (49) Gigg, J.; Gigg, R.; Payne, S.; Conant, R. *J. Chem. Soc., Perkin Trans. 1* **1987**, 2411.
- (50) Chung, S.-K.; Chang, Y.-T. *J. Chem. Soc., Chem. Commun.* **1995**, 11.
- (51) Riley, A. M.; Potter, B. V. L. *Tetrahedron Lett.* **1999**, *40*, 2213.
- (52) Hense, A.; Ley, S. V.; Osborn, H. M. I.; Owen, D. R.; Poisson, J.-F.; Warriner, S. L.; Wesson, K. E. *J. Chem. Soc., Perkin Trans. 1* **1997**, 2023.
- (53) Desai, T.; Fernandez-Mayoralas, A.; Gigg, J.; Gigg, R.; Payne, S. *Carbohydr. Res.* **1990**, *205*, 105.
- (54) Hosoda, A.; Nomura, E.; Mizuno, K.; Taniguchi, H. *J. Org. Chem.* **2001**, *66*, 7199.
- (55) (a) Laumen, K.; Ghisalpa, O. *Biosci., Biotechnol., Biochem.* **1999**, *63*, 1374. (b) Laumen, K.; Kittelmann, M.; Ghisalpa, O. *J. Mol. Catal. B* **2002**, *19*–20, 55.
- (56) Desai, T.; Gigg, J.; Gigg, R.; Payne, S. *Carbohydr. Res.* **1992**, *228*, 65.
- (57) (a) Edwards, P. J.; Entwistle, D. A.; Ley, S. V.; Owen, D. R.; Perry, E. J. *Tetrahedron: Asymmetry* **1994**, *5*, 553. (b) Edwards, P. J.; Entwistle, D. A.; Genicot, C.; Kim, K. S.; Ley, S. V. *Tetrahedron Lett.* **1994**, *35*, 7443. (c) Baeschlin, D. K.; Chaperon, A. R.; Green, L. G.; Hahn, M. G.; Ince, S. J.; Ley, S. V. *Chem.-Eur. J.* **2000**, *6*, 172.
- (58) Ley, S. V.; Mio, S.; Meseguer, B. *Synlett* **1996**, 791.
- (59) Vinod, T. K.; Griffith, O. H.; Keana, J. F. W. *Tetrahedron Lett.* **1994**, *35*, 7193.
- (60) (a) Salamończyk, G. M.; Pietrusiewicz, K. M. *Tetrahedron Lett.* **1994**, *35*, 4233. (b) Ling, L.; Ozaki, S. *Carbohydr. Res.* **1994**, *256*, 49. (c) Li, W.; Schultz, C.; Llopis, J.; Tsien, R. Y. *Tetrahedron* **1997**, *53*, 12017.
- (61) Ling, L.; Ozaki, S. *Tetrahedron Lett.* **1993**, *34*, 2501.
- (62) Watanabe, Y.; Ogasawara, T.; Ozaki, S.; Hirata, M. *Carbohydr. Res.* **1994**, *258*, 87.
- (63) (a) Angyal, S. J.; Melrose, G. J. H. *J. Chem. Soc.* **1965**, 6501. (b) Jaworek, C. H.; Iacobucci, S.; Calias, P.; d'Alarcao, M. *Carbohydr. Res.* **2001**, *331*, 375.
- (64) Gigg, J.; Gigg, R.; Martín-Zamora, E. *Tetrahedron Lett.* **1993**, *34*, 2827.
- (65) Salamończyk, G. M.; Pietrusiewicz, K. M. *Tetrahedron Lett.* **1991**, *32*, 6167.
- (66) Ballereau, S.; Guédat, P.; Spiess, B.; Rehnberg, N.; Schlewier, G. *Tetrahedron Lett.* **1995**, *36*, 7449.
- (67) (a) Watanabe, Y.; Yamamoto, T.; Ozaki, S. *J. Org. Chem.* **1996**, *61*, 14. (b) Watanabe, Y.; Yamamoto, T.; Okazaki, T. *Tetrahedron* **1997**, *53*, 903.
- (68) (a) Jia, Z. J.; Olsson, L.; Fraser-Reid, B. *J. Chem. Soc., Perkin Trans. 1* **1998**, 631. (b) Anilkumar, G. N.; Jia, Z. J.; Kraehmer, R.; Fraser-Reid, B. *J. Chem. Soc., Perkin Trans. 1* **1999**, 3591. (c) Anilkumar, G.; Gilbert, M. R.; Fraser-Reid, B. *Tetrahedron* **2000**, *56*, 1993. (d) Fraser-Reid, B.; Anilkumar, G. N.; Nair, L. G.; Radhakrishnan, K. V.; Lopez, J. C.; Gomez, A.; Uriel, C. *Aust. J. Chem.* **2002**, *55*, 123.
- (69) Chen, J.; Dormán, G.; Prestwich, G. D. *J. Org. Chem.* **1996**, *61*, 393.
- (70) Westerduin, P.; Willems, H. A. M.; van Boeckel, C. A. A. *Carbohydr. Res.* **1992**, *234*, 131.
- (71) (a) Sculimbene, B. R.; Miller, S. J. *J. Am. Chem. Soc.* **2001**, *123*, 10125. (b) Sculimbene, B. R.; Morgan, A. J.; Miller, S. J. *J. Am. Chem. Soc.* **2002**, *124*, 11653. (c) Sculimbene, B. R.; Morgan, A. J.; Miller, S. J. *Chem. Commun.* **2003**, 1781.
- (72) Chung, S.-K.; Chang, Y.-T. *Bioorg. Med. Chem. Lett.* **1997**, *7*, 2715.
- (73) Kim, K. S.; Cho, S. J.; Oh, K. S.; Son, J. S.; Kim, J.; Lee, J. Y.; Lee, S. J.; Lee, S.; Chang, Y.-T.; Chung, S.-K.; Ha, T.-K.; Lee, B.-S.; Lee, I. *J. Phys. Chem. A* **1997**, *101*, 3776.
- (74) (a) Biamonte, M. A.; Vasella, A. *Helv. Chim. Acta* **1998**, *81*, 695. (b) Chung, M.-K.; Orlova, G.; Goddard, J. D.; Schlaf, M.; Harris, R.; Beveridge, T. J.; White, G.; Hallett, F. R. *J. Am. Chem. Soc.* **2002**, *124*, 10508.
- (75) Sureshan, K. M.; Shashidhar, M. S. *Tetrahedron Lett.* **2000**, *41*, 4185.
- (76) (a) Sureshan, K. M.; Shashidhar, M. S. *Tetrahedron Lett.* **2001**, *42*, 3037. (b) Sureshan, K. M.; Shashidhar, M. S.; Praveen, T.; Gonnade, R. G.; Bhadbhade, M. M. *Carbohydr. Res.* **2002**, *337*, 2399.
- (77) Li, C.; Vasella, A. *Helv. Chim. Acta.* **1993**, *76*, 211.
- (78) (a) Billington, D. C.; Baker, R. *J. Chem. Soc., Chem. Commun.* **1987**, 1011. (b) deSolms, S. J.; Vacca, J. P.; Huff, J. R. *Tetrahedron Lett.* **1987**, *28*, 4503.
- (79) (a) Chung, S.-K.; Chang, Y.-T.; Lee, J. W.; Ji, Y.-K. *Korean J. Med. Chem.* **1997**, *7*, 82. (b) Flores-Mosquera, M.; Martín-Lomas, M.; Chiara, J. L. *Tetrahedron Lett.* **1998**, *39*, 5085.
- (80) Banerjee, T.; Shashidhar, M. S. *Tetrahedron Lett.* **1994**, *35*, 8053.
- (81) Riley, A. M.; Mahon, M. F.; Potter, B. V. L. *Angew. Chem., Int. Ed. Engl.* **1997**, *36*, 1472.
- (82) Craig, B. N.; Janssen, M. U.; Wickersham, B. M.; Rabb, D. M.; Chang, P. S.; O'Leary, D. J. *J. Org. Chem.* **1996**, *61*, 9610.
- (83) Riley, A. M.; Murphy, C. T.; Lindley, C. J.; Westwick, J.; Potter, B. V. L. *Bioorg. Med. Chem. Lett.* **1996**, *6*, 2197.
- (84) Ballereau, S.; Poirier, S. N.; Guillemette, G.; Spiess, B.; Schlewier, G. *J. Chem. Soc., Perkin Trans. 1* **1998**, 1859.
- (85) Sarmah, M. P.; Shashidhar, M. S. *Carbohydr. Res.* **2003**, *338*, 999.
- (86) Uhlmann, P.; Vasella, A. *Helv. Chim. Acta* **1992**, *75*, 1979.
- (87) Das, T.; Praveen, T.; Shashidhar, M. S. *Carbohydr. Res.* **1998**, *313*, 55.
- (88) Watanabe, Y.; Oka, A.; Shimizu, Y.; Ozaki, S. *Tetrahedron Lett.* **1990**, *31*, 2613.
- (89) Rukavishnikov, A. V.; Ryan, M.; Griffith, O. H.; Keana, J. F. W. *Bioorg. Med. Chem. Lett.* **1997**, *7*, 1239.
- (90) (a) Davies, J. H.; Malkin, T. *Nature* **1959**, *184*, 789. (b) Angyal, S. J.; Melrose, G. J. H. *J. Chem. Soc.* **1965**, 6494. (c) Shevchenko, V. P.; Lazurkina, T. Y.; Molotkovskii, Y. G.; Bergelson, L. D. *Bioorg. Khim.* **1977**, *3*, 252; *Chem. Abstr.* **1977**, *86*, 190385a. (d)

- Seitz, S. P.; Kaltenbach, R. F., III; Vreekamp, R. H.; Calabrese, J. C.; Perrella, F. W. *Bioorg. Med. Chem. Lett.* **1992**, *2*, 171. (e) Fauq, A. H.; Kozikowski, A. P.; Ognyanov, V. I.; Wilcox, R. A.; Nahorski, S. R. *J. Chem. Soc., Chem. Commun.* **1994**, 1301. (f) Roemer, S.; Stadler, C.; Rudolf, M. T.; Jastorf, B.; Schultz, C. *J. Chem. Soc., Perkin Trans. 1* **1996**, 1683. (g) Solomons, K. R. H.; Freeman, S.; Poyner, D. R.; Yafai, F. *J. Chem. Soc., Perkin Trans. 1* **1996**, 1845.
- (91) (a) Angyal, S. J.; Tate, M. E. *J. Chem. Soc.* **1965**, 6949. (b) Angyal, S. J.; Gilham, P. T.; Melrose, G. J. H. *J. Chem. Soc.* **1965**, 5252.
- (92) (a) Dreef, C. E.; Elie, C. J. J.; Hoogerhout, P.; van der Marel, G. A.; van Boom, J. H. *Tetrahedron Lett.* **1988**, *29*, 6513. (b) Watanabe, Y.; Ogasawara, T.; Nakahira, H.; Matsuki, T.; Ozaki, S. *Tetrahedron Lett.* **1988**, *29*, 5259.
- (93) (a) Gigg, R.; Warren, C. D. *Tetrahedron Lett.* **1966**, 7, 2415. (b) Nashed, M. A.; Anderson, L. *Tetrahedron Lett.* **1976**, *17*, 3503. (c) Gigg, J.; Gigg, R.; Payne, S.; Conant, R. *Carbohydr. Res.* **1985**, *140*, c1-c3. (d) Garigapati, V. R.; Roberts, M. F. *Tetrahedron Lett.* **1993**, *34*, 5579. (e) Cottaz, S.; Brimacombe, J. S.; Ferguson, M. A. J. *J. Chem. Soc., Perkin Trans. 1* **1993**, 2945. (f) Desai, T.; Gigg, J.; Gigg, R.; Martin-Zamora, E. *Carbohydr. Res.* **1994**, *262*, 59. (g) Gou, D.-M.; Chen, C.-S. *J. Chem. Soc., Chem. Commun.* **1994**, 2125. (h) Cottaz, S.; Brimacombe, J. S.; Ferguson, M. A. J. *Carbohydr. Res.* **1995**, *270*, 85. (i) Riley, A. M.; Potter, B. V. L. *Chem. Commun.* **2000**, 983. (j) Mills, S. J.; Liu, C.; Potter, B. V. L. *Carbohydr. Res.* **2002**, *337*, 1795. (k) Xue, J.; Shao, N.; Guo, Z. *J. Org. Chem.* **2003**, *68*, 4020.
- (94) (a) Watanabe, Y.; Hirofujii, H.; Ozaki, S. *Tetrahedron Lett.* **1994**, *35*, 123. (b) Watanabe, Y.; Tomioka, M.; Ozaki, S. *Tetrahedron Lett.* **1995**, *51*, 8969. (c) Falck, J. R.; Murali Krishna, U.; Katipally, K. R.; Capdevila, J. H.; Ulug, E. T. *Tetrahedron Lett.* **2000**, *41*, 4271.
- (95) (a) Ozaki, S.; Watanabe, Y.; Ogasawara, T.; Kondo, Y.; Shiotani, N.; Nishii, H.; Matsuki, T. *Tetrahedron Lett.* **1986**, *27*, 3157. (b) Ozaki, S.; Kondo, Y.; Nakahira, H.; Yamaoka, S.; Watanabe, Y. *Tetrahedron Lett.* **1987**, *28*, 4691. (c) Chida, N.; Koizumi, K.; Kitada, Y.; Yokoyama, C.; Ogasawa, S. *J. Chem. Soc., Chem. Commun.* **1994**, 111. (d) Aneja, R.; Parra, A. *Tetrahedron Lett.* **1994**, *35*, 525. (e) Mills, S. J.; Potter, B. V. L. *J. Org. Chem.* **1996**, *61*, 8980. (f) Mills, S. J.; Potter, B. V. L. *J. Chem. Soc., Perkin Trans. 1* **1997**, 1279.
- (96) (a) David, S.; Hanessian, S. *Tetrahedron* **1985**, *41*, 643. (b) Migaud, M. E.; Frost, J. W. *J. Am. Chem. Soc.* **1995**, *117*, 5154.
- (97) (a) Angyal, S. J.; Russel, A. F. *Aust. J. Chem.* **1969**, *22*, 391. (b) Gigg, J.; Gigg, R.; Payne, S.; Conant, R. *J. Chem. Soc., Perkin Trans. 1* **1987**, 423. (c) Kulagowski, J. J. *Tetrahedron Lett.* **1989**, *30*, 3869. (d) Shashidhar, M. S.; Keana, J. F. W.; Volwerk, J. J.; Griffith, O. H. *Chem. Phys. Lipids* **1990**, *53*, 103. (e) Dreef, C. E.; Tuinman, R. J.; Lefeber, A. W. M.; Elie, C. J. J.; van der Marel, G. A.; van Boom, J. H. *Tetrahedron* **1991**, *47*, 4709. (f) Chung, S.-K.; Chang, Y.-T.; Ryu, Y. *Pure Appl. Chem.* **1996**, *68*, 931. (g) Aneja, R.; Aneja, S. G.; Parra, A. *Tetrahedron Lett.* **1996**, *37*, 5081. (h) Fauroux, C. M.-J.; Lee, M.; Cullis, P. M.; Douglas, K. T.; Gore, M. G.; Freeman, S. *J. Med. Chem.* **2002**, *45*, 1363. (i) Watanabe, Y.; Munetsugu, H.; Hayashi, M. *Chem. Lett.* **2002**, 292.
- (98) Shashidhar, M. S.; Volwerk, J. J.; Griffith, O. H.; Keana, J. F. W. *Chem. Phys. Lipids* **1991**, *60*, 101.
- (99) Gauthier, D. R., Jr.; Bender, S. L. *Tetrahedron Lett.* **1996**, *37*, 13.
- (100) Ward, J. G.; Young, R. C. *Tetrahedron Lett.* **1988**, *29*, 6013.
- (101) Elie, C. J. J.; Verduyn, R.; Dreef, C. E.; Brounts, D. M.; van der Marel, G. A.; van Boom, J. H. *Tetrahedron* **1990**, *46*, 8243.
- (102) Chung, S.-K.; Ryu, Y.; Chang, Y.-T.; Whang, D.; Kim, K. *Carbohydr. Res.* **1994**, *253*, 13.
- (103) Spiers, I. D.; Schwalbe, C. H.; Blake, A. J.; Solomons, K. R. H.; Freeman, S. *Carbohydr. Res.* **1997**, *302*, 43.
- (104) Chung, S.-K.; Ryu, Y. *Carbohydr. Res.* **1994**, *258*, 145.
- (105) (a) Westerduin, P.; Willems, H. A. M.; van Boeckel, C. A. A. *Tetrahedron Lett.* **1990**, *31*, 6915. (b) Kratzer, B.; Mayer, T. G.; Schmidt, R. R. *Tetrahedron Lett.* **1993**, *34*, 6881. (c) Chen, C.-S. U.S. Patent US.5260472 A9, 1993. (d) Schmitt, L.; Spiess, B.; Schlewer, G. *Tetrahedron Lett.* **1998**, *39*, 4817. (e) Pekari, K.; Tailler, D.; Weingart, R.; Schmidt, R. R. *J. Org. Chem.* **2001**, *66*, 7432.
- (106) (a) Yu, K.-L.; Fraser-Reid, B. *Tetrahedron Lett.* **1988**, *29*, 979. (b) Liu, Y.-C.; Chen, C.-S. *Tetrahedron Lett.* **1989**, *30*, 1617. (c) Plourde, R.; d'Alencao, M. *Tetrahedron Lett.* **1990**, *31*, 2693. (d) Wang, D.-S.; Chen, C.-S. *J. Org. Chem.* **1996**, *61*, 5905. (e) Lim, Z.-Y.; Thuring, J. W.; Holmes, A. B.; Manifava, M.; Ktistakis, N. T. *J. Chem. Soc., Perkin Trans. 1* **2002**, 1067.
- (107) Xue, J.; Guo, Z. *Bioorg. Med. Chem. Lett.* **2002**, *12*, 2015.
- (108) Desai, T.; Gigg, J.; Gigg, R.; Payne, S. *Carbohydr. Res.* **1992**, *225*, 209.
- (109) Mihai, C.; Mataka, J.; Riddle, S.; Tsai, M.-D.; Bruzik, K. S. *Bioorg. Med. Chem. Lett.* **1997**, *7*, 1235.
- (110) (a) Han, F.; Hayashi, M.; Watanabe, Y. *Chem. Lett.* **2003**, *32*, 46. (b) Dinkel, C.; Schultz, C. *Tetrahedron Lett.* **2003**, *44*, 1157.
- (111) Anilkumar, G.; Nair, L. G.; Fraser-Reid, B. *Org. Lett.* **2000**, *2*, 2587.
- (112) Reddy, K. M.; Reddy, K. K.; Falck, J. R. *Tetrahedron Lett.* **1997**, *38*, 4951.
- (113) (a) Chung, S.-K.; Chang, Y.-T.; Sohn, K.-H. *Chem. Commun.* **1996**, 163. (b) Watanabe, Y.; Nakatomi, M. *Tetrahedron Lett.* **1998**, *39*, 1583. (c) Watanabe, Y.; Ishikawa, H. *Tetrahedron Lett.* **2000**, *41*, 8509. (d) Chung, S.-K.; Kwon, Y.-U.; Shin, J. H.; Chang, Y.-T.; Lee, C.; Shin, B.-G.; Kim, K.-C.; Kim, M.-J. *J. Org. Chem.* **2002**, *67*, 5626.
- (114) (a) Gou, D.-M.; Chen, C.-S. *Tetrahedron Lett.* **1992**, *33*, 721. (b) Gou, D.-M.; Liu, Y.-C.; Chen, C.-S. *Carbohydr. Res.* **1992**, *234*, 51. (c) Dietrich, H.; Espinosa, J. F.; Chiara, J. L.; Jimenez-Barbero, P.; Leon, Y.; Varela-Nieto, I.; Mato, J.-M.; Cano, F. H.; Foces-Foces, C.; Martín-Lomas, M. *Chem.-Eur. J.* **1999**, *5*, 320.
- (115) Ling, L.; Li, X.; Watanabe, Y.; Akiyama, T.; Ozaki, S. *Bioorg. Med. Chem.* **1993**, *1*, 155.
- (116) (a) Vacca, J. P.; deSolms, S. J.; Huff, J. R. *J. Am. Chem. Soc.* **1987**, *109*, 3478. (b) Lu, P.-J.; Gou, D.-M.; Shieh, W.-R.; Chen, C.-S. *Biochemistry* **1994**, *33*, 11586. (c) Aneja, S. G.; Parra, A.; Stoescu, C.; Xia, W.; Aneja, R. *Tetrahedron Lett.* **1997**, *38*, 803. (d) Ravikumar, K. S.; Farquhar, D. *Tetrahedron Lett.* **2002**, *43*, 1367.
- (117) Schlueter, U.; Lu, J.; Fraser-Reid, B. *Org. Lett.* **2003**, *5*, 255.
- (118) (a) Gilbert, I. H.; Holmes, A. B.; Young, R. C. *Tetrahedron Lett.* **1990**, *31*, 2633. (b) Gilbert, I. H.; Holmes, A. B.; Pestchanker, M. J.; Young, R. C. *Carbohydr. Res.* **1992**, *234*, 117. (c) Yeh, S.-M.; Lee, G. H.; Wang, Y.; Luh, T.-Y. *J. Org. Chem.* **1997**, *62*, 8315. (d) Riley, A. M.; Potter, B. V. L. *Tetrahedron Lett.* **1998**, *39*, 6769. (e) Painter, G. F.; Grove, S. J. A.; Gilbert, I. H.; Holmes, A. B.; Raithby, P. R.; Hill, M. L.; Hawkins, P. T.; Stephens, L. R. *J. Chem. Soc., Perkin Trans. 1* **1999**, 923.
- (119) Lemieux, R. U.; Driguez, H. *J. Am. Chem. Soc.* **1975**, *97*, 4069.
- (120) Khersonsky, S. M.; Chang, Y.-T. *Carbohydr. Res.* **2002**, *337*, 75.
- (121) (a) Mitchell, A. G.; Thomson, W.; Nicholls, D.; Irwin, W. J.; Freeman, S. *J. Chem. Soc., Perkin Trans. 1* **1992**, 2345. (b) Vajnanaphanich, M.; Schultz, C.; Rudolf, M. T.; Wasserman, M.; Enyed, P.; Carxton, A.; Shears, S. B.; Tsien, R. Y.; Barrett, K. E.; Traynor-Kaplan, A. *Nature* **1994**, *371*, 711. (c) Farquhar, D.; Khan, S.; Wilkerson, M. C.; Anderson, B. S. *Tetrahedron Lett.* **1995**, *36*, 655. (d) Roemer, S.; Rudolf, M. T.; Stadler, C.; Schultz, C. *J. Chem. Soc., Chem. Commun.* **1995**, 411. (e) Rudolf, M. T.; Li, W.-H.; Wolfson, N.; Traynor-Kaplan, A. E.; Schultz, C. *J. Med. Chem.* **1998**, *41*, 3635.
- (122) (a) Kosuge, T.; Zenda, H.; Ochiai, A.; Masaki, N.; Noguchi, M.; Kimura, S.; Narita, H. *Tetrahedron Lett.* **1972**, *13*, 2545. (b) Kosuge, T.; Tsuji, K.; Hirai, K.; Yamaguchi, K.; Okamoto, T.; Iitaka, Y. *Tetrahedron Lett.* **1981**, *22*, 3417. (c) Kosuge, T.; Tsuji, K.; Hirai, K. *Chem. Pharm. Bull.* **1982**, *30*, 3255. (d) Inoue, S.; Okada, K.; Tanino, H.; Kakoi, H. *Heterocycles* **1992**, *33*, 701.
- (123) Euranto E. K. In *The Chemistry of Carboxylic Acids and Esters*; Patai, S., Ed.; John Wiley & Sons Ltd.: New York, 1969; p 542.
- (124) Praveen, T.; Das, T.; Sureshan, K. M.; Shashidhar, M. S.; Samanta, U.; Pal, D.; Chakrabarti, P. *J. Chem. Soc., Perkin Trans. 2* **2002**, 358.
- (125) (a) Das, T.; Shashidhar, M. S. *Carbohydr. Res.* **1997**, *297*, 243. (b) Das, T.; Shashidhar, M. S. *Carbohydr. Res.* **1998**, *308*, 165. (c) Sureshan, K. M.; Das, T.; Shashidhar, M. S.; Gonnade, R. G.; Bhadbhade, M. M. *Eur. J. Org. Chem.* **2003**, 1035.
- (126) Meek, J. L.; Davidson, F.; Hobbs, F. W., Jr. *J. Am. Chem. Soc.* **1988**, *110*, 2317.
- (127) (a) Chung, S.-K.; Chang, Y.-T. *J. Chem. Soc., Chem. Commun.* **1995**, 13. (b) Chung, S.-K.; Chang, Y.-T. *Korean J. Med. Chem.* **1996**, *6*, 162. (c) Chung, S.-K.; Chang, Y.-T.; Kwon, Y.-V. *J. Carbohydr. Chem.* **1996**, *17*, 369. (d) Chung, S.-K.; Chang, Y.-T.; Sohn, K.-H. *Chem. Commun.* **1996**, 163. (e) Chung, S.-K.; Chang, Y.-T. *Bioorg. Med. Chem. Lett.* **1996**, *6*, 2039.
- (128) Chung, S.-K.; Chang, Y.-T.; Whang, D.; Kim, K. *Carbohydr. Res.* **1996**, *295*, 1.
- (129) Praveen, T.; Samanta, U.; Das, T.; Shashidhar, M. S.; Chakrabarti, P. *J. Am. Chem. Soc.* **1998**, *120*, 3842.
- (130) Blum, C.; Karlsson, S.; Schlewer, G.; Spiess, B.; Rehnberg, N. *Tetrahedron Lett.* **1995**, *36*, 7239.
- (131) Bruzik, K. S.; Guan, Z.; Riddle, S.; Tsai, M.-D. *J. Am. Chem. Soc.* **1996**, *118*, 7679.
- (132) Angyal, S. J.; Randall, M. H.; Tate, M. E. *J. Chem. Soc. (C)* **1967**, 919.
- (133) Falck, J. R.; Barma, D. K.; Venkataraman, S. K.; Baati, R.; Mikosowski, C. *Tetrahedron Lett.* **2002**, *43*, 963.
- (134) Takahashi, H.; Kittaka, H.; Ikegami, S. *J. Org. Chem.* **2001**, *66*, 2705.
- (135) (a) Angyal, S. J.; Hoskinson, R. M. *Methods Carbohydr. Chem.* **1963**, *2*, 87. (b) McCasland, G. E.; Naumann, M. O.; Durham, L. J. *J. Org. Chem.* **1968**, *33*, 4220.
- (136) Miethchen, R.; Sowa, C.; Frank, M.; Michalik, M.; Reinke, H. *Carbohydr. Res.* **2002**, *337*, 1.
- (137) (a) Falshaw, A.; Hart, J. B.; Tyler, P. C. *Carbohydr. Res.* **2000**, *329*, 301. (b) Liu, C.; Riley, A. M.; Yang, X.; Shears, S. B.; Potter, B. V. L. *J. Med. Chem.* **2001**, *44*, 2984.

- (138) Tagliaferri, F.; Johnson, S. C.; Seiple, T. F.; Baker, D. C. *Carbohydr. Res.* **1995**, *266*, 301.
- (139) (a) Jaramillo, C.; Chiara, J.-L.; Martín-Lomas, M. *J. Org. Chem.* **1994**, *59*, 3135. (b) Liu, C.; Davis, R. J.; Nahorski, S. R.; Ballereau, S.; Spiess, B.; Potter, B. V. L. *J. Med. Chem.* **1999**, *42*, 1991. (c) Martín-Lomas, M.; Flores-Mosquera, M.; Khiar, N. *Eur. J. Org. Chem.* **2000**, 1539. (d) Cid, M. B.; Bonilla, J. B.; Dumarçay, S.; Alfonso, F.; Martín-Lomas, M. *Eur. J. Org. Chem.* **2002**, 881.
- (140) (a) Carless, H. A. J.; Busia, K. *Carbohydr. Res.* **1992**, *234*, 207. (b) Liu, C.; Al-Hafidh, J.; Westwick, J.; Potter, B. V. L. *Bioorg. Med. Chem.* **1994**, *2*, 253. (c) Lampe, D.; Liu, C.; Potter, B. V. L. *J. Med. Chem.* **1994**, *37*, 907.
- (141) Bruzik, K. S.; Hakeem, A. A.; Tsai, M.-D. *Biochemistry* **1994**, *33*, 8367.
- (142) (a) Kozikowski, A. P.; Fauq, A. H.; Powis, G.; Melder, D. C. *J. Am. Chem. Soc.* **1990**, *112*, 4528. (b) Larner, J.; Price, J. D.; Heimark, D.; Smith, L.; Rule, G.; Piccariello, T.; Fonteles, M. C.; Pontes, C.; Vale, D.; Huang, L. *J. Med. Chem.* **2003**, *46*, 3283.
- (143) Kozikowski, A. P.; Ognyanov, V. I.; Fauq, A. H.; Wilcox, R. A.; Nahorski, S. R. *J. Chem. Soc., Chem. Commun.* **1994**, 599.
- (144) Garegg, P. J.; Kvarnström, I. *Carbohydr. Res.* **1981**, *90*, 61.
- (145) Bonilla, J. B.; Muñoz-Ponce, J. L.; Nieto, P. M.; Cid, M. B.; Khiar, N.; Martín-Lomas, M. *Eur. J. Org. Chem.* **2002**, 889.
- (146) Tegge, W.; Ballou, C. E. *Proc. Natl. Acad. Sci. U.S.A.* **1989**, *86*, 94.
- (147) (a) Carless, H. A. J.; Busia, K. *Tetrahedron Lett.* **1990**, *31*, 1617. (b) Reddy, K. K.; Falck, J. R.; Capdevila, J. *Tetrahedron Lett.* **1993**, *34*, 7869. (c) Kornienko, A.; Marnera, G.; d'Alarcao, M. *Carbohydr. Res.* **1998**, *310*, 141.
- (148) Paulsen, H.; von Deyn, W.; Röben, W. *Justus Liebigs Ann. Chem.* **1984**, 433.
- (149) Cousins, G.; Falshaw, A.; Hoberg, J. O. *Carbohydr. Res.* **2003**, *338*, 995.
- (150) Akiyama, T.; Nishimoto, H.; Kuwata, T.; Ozaki, S. *Bull. Chem. Soc. Jpn.* **1994**, *67*, 180.
- (151) Mercier, D.; Barnett, J. E. G.; Géro, S. D. *Tetrahedron* **1969**, *25*, 5681.
- (152) (a) Chung, S.-K.; Yu, S.-H. *Bioorg. Med. Chem. Lett.* **1996**, *6*, 1461. (b) Chung, S.-K.; Yu, S.-H. *Korean J. Med. Chem.* **1996**, *6*, 35.
- (153) McCasland, G. E.; Naumann, M. O.; Durham, L. J. *J. Org. Chem.* **1969**, *34*, 1382.
- (154) Chung, S.-K.; Kwon, Y.-U.; Chang, Y.-T.; Sohn, K.-H.; Shin, J.-H.; Park, K.-H.; Hong, B.-J.; Chung, I.-H. *Bioorg. Med. Chem.* **1999**, *7*, 2577.
- (155) (a) Vogl, O.; Anderson, B. C.; Simons, D. M. *J. Org. Chem.* **1969**, *34*, 4, 204. (b) Husson, C.; Odier, L.; Vottéro, Ph. J. A. *Carbohydr. Res.* **1998**, *307*, 163.
- (156) Angyal, S. J.; Hickman, R. J. *Carbohydr. Res.* **1971**, *20*, 97.
- (157) (a) Anderson, R. C.; Wallis, E. S. *J. Am. Chem. Soc.* **1948**, *70*, 2931. (b) Angyal, S. J.; Odier, L.; Tate, M. E. *Carbohydr. Res.* **1995**, *266*, 143 and references therein.
- (158) Espelie, K. E.; Anderson, L. *Carbohydr. Res.* **1976**, *46*, 53.
- (159) Burmester, A.; Jastorff, B. *J. Chromatogr.* **1996**, *749*, 25.
- (160) Chida, N.; Ogawa, S. *Chem. Commun.* **1997**, 807.
- (161) (a) Akiyama, T.; Horiguchi, N.; Ida, T.; Ozaki, S. *Chem. Lett.* **1995**, 975 and references therein. (b) Akiyama, T.; Hara, M.; Fuchibe, K.; Sakamoto, S.; Yamaguchi, K. *Chem. Commun.* **2003**, 1734.
- (162) (a) Hegetschweiler, K. *Chem. Soc. Rev.* **1999**, *28*, 239. (b) Tae, J.; Rogers, R. D.; Paquette, L. A. *Org. Lett.* **2000**, *2*, 139. (c) Paquette, L. A.; Tae, J.; Gallucci, J. C. *Org. Lett.* **2000**, *2*, 143. (d) Kim, T.-H.; Holmes, A. B. *J. Chem. Soc., Perkin Trans. 1* **2001**, 2524. (e) Sureshan, K. M.; Shashidhar, M. S.; Varma, A. J. *J. Chem. Soc., Perkin Trans. 2* **2001**, 2298. (f) Paquette, L. A.; Ra, C. S.; Gallucci, J. C.; Kang, H.-J.; Ohmori, N.; Arrington, M. P.; David, W.; Brodbelt, J. S. *J. Org. Chem.* **2001**, *66*, 8629. (g) Paquette, L. A.; Tae, J. *J. Am. Chem. Soc.* **2001**, *123*, 4974. (h) Sureshan, K. M.; Shashidhar, M. S.; Varma, A. J. *J. Org. Chem.* **2002**, *67*, 6884.
- (163) Sureshan, K. M.; Gonnade, R. G.; Shashidhar, M. S.; Puranik, V. G.; Bhadbhade, M. M. *Chem. Commun.* **2001**, 881.
- (164) Praefcke, C.; Blunk, D. *Liquid Cryst.* **1993**, *14*, 1181.
- (165) (a) Kim, T.-H.; Dokolas, P.; Feeder, N.; Giles, M.; Holmes, A. B.; Walther, M. *Chem. Commun.* **2000**, 2419. (b) Kim, T.-H.; Giles, M.; Holmes, A. B. *Chem. Commun.* **2000**, 2421.

CR0200724

